

AC Servo Drives

Σ -V Series

USER'S MANUAL

For Use with Large-Capacity Models Setup

Rotational Motor

SGDV SERVOPACK
SGMVV Servomotor

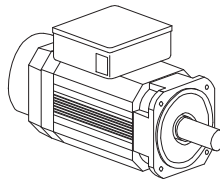
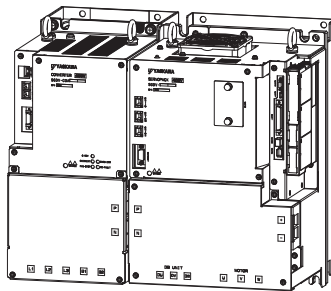

Overview of Setup **1**

Installation **2**

Wiring and Connection **3**

Safety Function **4**

Trial Operation
(Checking Servomotor Operation) **5**

Copyright © 2012 YASKAWA ELECTRIC CORPORATION

All rights reserved. No part of this publication may be reproduced, stored in a retrieval system, or transmitted, in any form, or by any means, mechanical, electronic, photocopying, recording, or otherwise, without the prior written permission of Yaskawa. No patent liability is assumed with respect to the use of the information contained herein. Moreover, because Yaskawa is constantly striving to improve its high-quality products, the information contained in this manual is subject to change without notice. Every precaution has been taken in the preparation of this manual. Nevertheless, Yaskawa assumes no responsibility for errors or omissions. Neither is any liability assumed for damages resulting from the use of the information contained in this publication.

About this Manual

This manual describes procedures required for installation, wiring, and connecting Σ -V Series servo drives, including a JOG operation for servomotors not connected to machinery.

Be sure to refer to this manual and perform setup operations correctly.

Keep this manual in a location where it can be accessed for reference whenever required.

■ Description of Technical Terms

The following table shows the meanings of terms used in this manual.

Term	Meaning
Servomotor	Σ -V Series SGMVV servomotor
SERVOPACK	Σ -V Series SGD \square V- $\square\square\square$ H and SGD \square V- $\square\square\square$ J SERVOPACKs
Converter	Σ -V Series SGD \square V-COA converter
Servo Drive	A set that includes a Servomotor, SGD \square V- $\square\square\square$ H and SGD \square V- $\square\square\square$ J SERVOPACKs, and converter.
Servo System	A servo control system that includes the combination of a servo drive with a host controller and peripheral devices
Analog pulse model	A SERVOPACK with an analog voltage interface or a pulse train interface.
M-II model	A SERVOPACK with a MECHATROLINK-II communications reference interface.
M-III model	A SERVOPACK with a MECHATROLINK-III communications reference interface.
Command option attachable type	A SERVOPACK with a Reference Option Module mounted to it.
Servo ON	Power to motor ON
Servo OFF	Power to motor OFF
Base Block (BB)	Power supply to motor is turned OFF by shutting off the base current to the power transistor in the current amplifier.
Main Circuit Cable	Cables which connect to the main circuit terminals, including main circuit power supply cables, control power supply cables, servomotor main circuit cables, and others.
Cursor	Input position indicated by Digital Operator

■ IMPORTANT Explanations

The following icon is displayed for explanations requiring special attention.



- Indicates important information that should be memorized, as well as precautions, such as alarm displays, that do not involve potential damage to equipment.

■ Notation Used in this Manual

In this manual, the names of reverse signals (ones that are valid when low) are written with a forward slash (/) before the signal name, as shown in the following example:

Example

$\overline{S-ON} = /S-ON$

■ Manuals Related to the Σ -V Series

Refer to the following manuals as required.

Name	Selecting Models and Peripheral Devices	Ratings and Specifications	System Design	Panels and Wiring	Trial Operation	Trial Operation and Servo Adjustment	Maintenance and Inspection
Large-Capacity Σ -V Series Product Catalog (KAEP S800000 86)	✓	✓					
Σ -V Series User's Manual For Use with Large-Capacity Models Design and Maintenance Rotational Motor/ Analog Voltage and Pulse Train Reference (SIEP S800000 88)		✓	✓	✓		✓	✓*
Σ -V Series User's Manual For Use with Large-Capacity Models Design and Maintenance Rotational Motor/ MECHATROLINK-II Communications Reference (SIEP S800000 90)		✓	✓	✓		✓	✓*

(cont'd)

Name	Selecting Models and Peripheral Devices	Ratings and Specifications	System Design	Panels and Wiring	Trial Operation	Trial Operation and Servo Adjustment	Maintenance and Inspection
Σ -V Series/DC Power Input Σ -V Series/ Σ -V Series for Large Capacity Models User's Manual MECHATROLINK-II Command (SIEP S800000 54)			✓		✓	✓	
Σ -V Series User's Manual For Use with Large-Capacity Models Design and Maintenance Rotational Motor/ MECHATROLINK-III Communications Reference (SIEP S800000 93)		✓	✓	✓		✓	✓*
Σ -V Series/DC Power Input Σ -V Series/ Σ -V Series for Large Capacity Models User's Manual MECHATROLINK-III Command (SIEP S800000 63)			✓		✓	✓	
Σ -V Series User's Manual For Use with Large-Capacity Models Design and Maintenance Rotational Motor/ Command Option Attachable Type (SIEP S800000 98)		✓	✓	✓		✓	✓
Σ -V Series User's Manual Operation of Digital Operator (SIEP S800000 55)					✓	✓	✓
Σ -V Series/ Σ -V Series for Large Capacity Models User's Manual Indexer Module (SIEP C720829 02)		✓	✓	✓		✓	✓*

(cont'd)

Name	Selecting Models and Peripheral Devices	Ratings and Specifications	System Design	Panels and Wiring	Trial Operation	Trial Operation and Servo Adjustment	Maintenance and Inspection
Σ -V Series User's Manual For DeviceNet Module (SIEP C720829 07)		✓	✓	✓		✓	✓*
AC Servomotor Safety Precautions (TOBP C230200 00)				✓			✓
AC SERVOPACK and Converter Σ -V Series Safety Precautions For Use with Large-Capacity Models (TOBP C710829 07)	✓			✓			✓
Σ -V Series/ Σ -V Series for Large Capacity Models Option Module Safety Precautions (TOBP C720829 00)	✓			✓			✓
Σ Series Digital Operator Safety Precautions (TOBP C730800 00)							✓

* Refer to these manuals for troubleshooting of problems which may occur during setup. (Troubleshooting which is common for command option modules is described in *Σ -V Series User's Manual For Use with Large- Capacity Models Design and Maintenance Rotational Motor/Command Option Attachable Type*.)

■ Safety Information

The following conventions are used to indicate precautions in this manual. Failure to heed precautions provided in this manual can result in serious or possibly even fatal injury or damage to the products or to related equipment and systems.





Indicates precautions that, if not heeded, could possibly result in loss of life or serious injury.

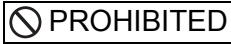

Indicates precautions that, if not heeded, could result in relatively serious or minor injury, damage to the product, or faulty operation.

In some situations, the precautions indicated could have serious consequences if not heeded.



Indicates prohibited actions that must not be performed. For example, this symbol would be used to indicate that fire is prohibited as follows: 



Indicates compulsory actions that must be performed. For example, this symbol would be used as follows to indicate that grounding is compulsory: 



Safety Precautions

These safety precautions are very important. Read them before performing any procedures such as checking products on delivery, storage and transportation, installation, wiring, operation and inspection, or disposal. Be sure to always observe these precautions thoroughly.

WARNING

- Never touch any rotating motor parts while the motor is running.
Failure to observe this warning may result in injury.
- Before starting operation with a machine connected, make sure that an emergency stop can be applied at any time.
Failure to observe this warning may result in injury or damage to the product.
- Never touch the inside of the SERVOPACKs and the converters.
Failure to observe this warning may result in electric shock.
- Do not remove the front cover of the power supply terminals while the power is ON.
Failure to observe this warning may result in electric shock.
- Immediately after the power is turned OFF or after a voltage resistance test, do not touch terminals while the CHARGE lamp is ON. For details on the charging time of the main circuit's capacitor, refer to 3.2 *Discharging Time of the Main Circuit's Capacitor*.
Residual voltage may cause electric shock.
- Follow the procedures and instructions provided in this manual for trial operation.
Failure to do so may result not only in faulty operation and damage to equipment, but also in personal injury.
- The output range of the rotational serial data for the absolute position detecting system used for Σ -V large-capacity servo drives is different from that of earlier systems for 12-bit and 15-bit encoders. As a result, the infinite-length positioning system of the Σ servo drives must be changed for use with Σ -V large-capacity servo drives. Be sure to make the system modifications.
- The multi-turn limit value need not be changed except for special applications.
Changing it inappropriately or unintentionally can be dangerous.
- If the Multi-turn Limit Disagreement alarm occurs, check the setting of parameter Pn205 in the SERVOPACK to be sure that it is correct.
If Fn013 is executed when an incorrect value is set in Pn205, an incorrect value will be set in the encoder. The alarm will disappear even if an incorrect value is set, but incorrect positions will be detected, resulting in a dangerous situation where the machine will move to unexpected positions.
- Do not remove the front cover, cables, connectors, or optional items from the front of the SERVOPACK and the converter while the power is ON.
Failure to observe this warning may result in electric shock or damage to the product.
- Do not damage, press, exert excessive force on, or place heavy objects on the cables.
Failure to observe this warning may result in electric shock, stopping operation of the product, or fire.

WARNING

- Do not modify the product.
Failure to observe this warning may result in injury, fire, or damage to the product.
- Provide an appropriate braking device on the machine side to ensure safety. The holding brake on a servomotor with a brake is not a braking device for ensuring safety.
Failure to observe this warning may result in injury.
- Do not come close to the machine immediately after resetting a momentary power loss. The machine may restart unexpectedly. Take appropriate measures to ensure safety against an unexpected restart.
Failure to observe this warning may result in injury.
- Do not wire the regenerative resistor unit incorrectly. Never short-circuit the B1 and B2 terminals.
Failure to observe this warning may result in fire or damage to the product.
-  Connect the ground terminal according to local electrical codes (100 Ω or less for a SERVOPACK and a converter with a 200 V power supply. 10 Ω or less for a SERVOPACK and a converter with 400 V power supply).
Improper grounding may result in electric shock or fire.
- Be sure to connect the servomotor's built-in thermostat to the host controller or to the main circuit magnetic contactor's operation circuit.
For details, refer to  *Protecting the Servomotor* in 2.2.5 *Other Precautions*.
Failure to observe this warning may result in injury, fire, or damage to the product.
-  Installation, disassembly, or repair must be performed only by authorized personnel.
Failure to observe this warning may result in electric shock or injury.
- The person who designs a system using the safety function (Hard Wire Baseblock function) must have full knowledge of the related safety standards and full understanding of the instructions in *Σ -V Series User's Manual For Use with Large-Capacity Models Design and Maintenance*.
Failure to observe this warning may result in injury or damage to the product.

■ Storage and Transportation

CAUTION

- Do not store or install the product in the following locations. Failure to observe this caution may result in fire, electric shock, or damage to the product.
 - Locations subject to direct sunlight
 - Locations subject to temperatures outside the range specified in the storage/installation temperature conditions
 - Locations subject to humidity outside the range specified in the storage/installation humidity conditions
 - Locations subject to condensation as the result of extreme changes in temperature
 - Locations subject to corrosive or flammable gases
 - Locations subject to dust, salts, or iron dust
 - Locations subject to exposure to water, oil, or chemicals
 - Locations subject to shock or vibration
- Do not hold the product by the cables, motor shaft, or terminal box while transporting it. Failure to observe this caution may result in injury or malfunction.
- Do not place any load exceeding the limit specified on the packing box. Failure to observe this caution may result in injury or malfunction.
- If disinfectants or insecticides must be used to treat packing materials such as wooden frames, pallets, or plywood, the packing materials must be treated before the product is packaged, and methods other than fumigation must be used.
Example: Heat treatment, where materials are kiln-dried to a core temperature of 56°C for 30 minutes or more.
If the electronic products, which include stand-alone products and products installed in machines, are packed with fumigated wooden materials, the electrical components may be greatly damaged by the gases or fumes resulting from the fumigation process. In particular, disinfectants containing halogen, which includes chlorine, fluorine, bromine, or iodine can contribute to the erosion of the capacitors.

■ Installation

CAUTION

- Never use the product in an environment subject to water, corrosive gases, inflammable gases, or combustibles.
Failure to observe this caution may result in electric shock or fire.
- Do not step on or place a heavy object on the product.
Failure to observe this caution may result in injury or malfunction.
- Do not cover the inlet or outlet ports and prevent any foreign objects from entering the product.
Failure to observe this caution may cause internal elements to deteriorate resulting in malfunction or fire.
- Be sure to install the product in the correct direction.
Failure to observe this caution may result in malfunction.
- Provide the specified clearances between the SERVOPACK and the converter and the control panel or with other devices.
Failure to observe this caution may result in fire or malfunction.
- Do not apply any strong impact.
Failure to observe this caution may result in malfunction.

■ Wiring

CAUTION

- Be sure to wire correctly and securely.
Failure to observe this caution may result in motor overrun, injury, or malfunction.
- Do not connect a commercial power supply to the U, V, or W terminals for the servomotor connection.
Failure to observe this caution may result in injury or fire.
- Securely connect the main circuit terminals.
Failure to observe this caution may result in fire.
- Do not bundle or run the main circuit cables together with the I/O signal cables or the encoder cables in the same duct. Keep them separated by at least 30 cm.
Failure to do so may result in malfunction.
- Use shielded twisted-pair wires or multi-core shielded twisted-pair wires for I/O signal cables and encoder cables.
- Use the bus bars that are included with the converter, and connect the P and N terminals on the SERVOPACK and converter securely.
- The maximum cable length is 3 m for I/O signal cables, 50 m for connection cables for servomotor main circuit or encoder cables, and 10 m for control power supply cables to 400-V converters (+24 V, 0 V).
- Do not touch the power terminals while discharging the main circuit's capacitor, because high voltage may still remain in the SERVOPACK and the converter. For details on the charging time of the main circuit's capacitor, refer to 3.2 *Discharging Time of the Main Circuit's Capacitor*.
Before starting to do wiring or inspections, confirm that the power has been completely discharged (charge indicator: OFF) by using a tester to measure the voltage between the P and N terminals for DC power.

■ Wiring (cont'd)

CAUTION

- Be sure to observe the following precautions when wiring the main circuit's terminals and connectors on a SERVOPACK or converter.
 - Do not turn ON the power to a SERVOPACK or converter until all wiring, including the wiring to the main circuit terminals, has been completed.
 - Remove detachable main circuit terminals from the SERVOPACK and the converter prior to wiring.
 - Insert only one power line per opening in the main circuit terminals.
 - Make sure that no part of the core wire comes into contact with (i.e., short-circuits) adjacent wires.
- Install a battery at either the host controller or the battery unit of the encoder, but not both.

It is dangerous to install batteries at both ends simultaneously, because that sets up a loop circuit between the batteries.
- Always use the specified power supply voltage.

An incorrect voltage may result in fire or malfunction.
- Make sure that the polarity is correct.

Incorrect polarity may cause ruptures or damage.
- Take appropriate measures to ensure that the input power supply is supplied within the specified voltage fluctuation range. Be particularly careful in places where the power supply is unstable.

An incorrect power supply may result in damage to the product.
- Install external breakers or other safety devices against short-circuiting in external wiring.

Failure to observe this caution may result in fire.
- Take appropriate and sufficient countermeasures for each form of potential interference when installing systems in the following locations.
 - Locations subject to static electricity or other forms of noise
 - Locations subject to strong electromagnetic fields and magnetic fields
 - Locations subject to possible exposure to radioactivity
 - Locations close to power supplies

Failure to observe this caution may result in damage to the product.
- Do not reverse the polarity of the battery when connecting it.

Failure to observe this caution may damage the battery, the SERVOPACK, or servomotor, or cause an explosion.
- Wiring or inspection must be performed by a technical expert.
- Use a 24-VDC power supply for the control power of 400-V converter with double insulation or reinforced insulation.

■ Operation

CAUTION

- Always use the servomotor, the SERVOPACK, and the converter in one of the specified combinations.
Failure to observe this caution may result in fire or malfunction.
- Conduct trial operations on the servomotor alone, with the motor shaft disconnected from the machine to avoid accidents.
Failure to observe this caution may result in injury.
- During trial operation, confirm that the holding brake works correctly. Furthermore, secure system safety against problems such as signal line disconnection.
Failure to observe this caution may result in injury or damage to the product.
- Before starting operation with a machine connected, change the settings to match the parameters of the machine.
Starting operation without matching the proper settings may cause the machine to run out of control or malfunction.
- Do not frequently turn power ON and OFF.
 - Frequently turning power ON and OFF causes elements inside the SERVOPACK and the converter to deteriorate. Do not use the servo drive with an application that requires frequently turning power ON and OFF.
 - After the actual operation starts, the allowable interval for turning power ON and OFF is one hour or longer.
- When using JOG operations (Fn002) origin search operations (Fn003), or EasyFFT operations (Fn206), the dynamic brake function does not work for reverse overtravel or forward overtravel. Take necessary precautions.
Failure to observe this caution may result in damage to the product.
- When using the servomotor for a vertical axis, install safety devices to prevent workpieces from falling due to alarms or overtravels. Set the servomotor so that it will stop in the zero clamp state when overtravel occurs.
Failure to observe this caution may cause workpieces to fall due to overtravel.
- When not using tuning-less function, set to the correct moment of inertia ratio (Pn103).
Setting to an incorrect moment of inertia ratio may cause vibration.
- Do not touch the SERVOPACK and the converter heatsinks, regenerative resistor, or servomotor while power is ON or soon after the power is turned OFF.
Failure to observe this caution may result in burns due to high temperatures.
- Do not make any extreme adjustments or setting changes of parameters.
Failure to observe this caution may result in injury or damage to the product due to unstable operation.
- When an alarm occurs, remove the cause, reset the alarm after confirming safety, and then resume operation.
Failure to observe this caution may result in damage to the product, fire, or injury.
- Do not use the holding brake of the servomotor for braking.
Failure to observe this caution may result in malfunction.
- An alarm or warning may occur if communications are performed with the host controller while the SigmaWin+ or Digital Operator is operating.
If an alarm or warning occurs, it may stop the current process and stop the system.

■ Maintenance and Inspection

CAUTION

- Do not disassemble the SERVOPACK and the converter.
Failure to observe this caution may result in electric shock or injury.
- Do not attempt to change wiring while the power is ON.
Failure to observe this caution may result in electric shock or injury.
- When replacing the SERVOPACK, resume operation only after copying the previous SERVOPACK parameters to the new SERVOPACK.
Failure to observe this caution may result in damage to the product.
- Be sure to eliminate static electricity before operating buttons and switches inside the plastic cover.
Failure to observe this caution may result in damage to the product.

■ Disposal

CAUTION

- When disposing of the products, treat them as ordinary industrial waste.

■ General Precautions

Observe the following general precautions to ensure safe application.

- The products shown in illustrations in this manual are sometimes shown without covers or protective guards. Always replace the cover or protective guard as specified first, and then operate the products in accordance with the manual.
- The drawings presented in this manual are typical examples and may not match the product you received.
- If the manual must be ordered due to loss or damage, inform your nearest Yaskawa representative or one of the offices listed on the back of this manual.

Warranty

(1) Details of Warranty

■ Warranty Period

The warranty period for a product that was purchased (hereinafter called "delivered product") is one year from the time of delivery to the location specified by the customer or 18 months from the time of shipment from the Yaskawa factory, whichever is sooner.

■ Warranty Scope

Yaskawa shall replace or repair a defective product free of charge if a defect attributable to Yaskawa occurs during the warranty period above. This warranty does not cover defects caused by the delivered product reaching the end of its service life and replacement of parts that require replacement or that have a limited service life.

This warranty does not cover failures that result from any of the following causes.

1. Improper handling, abuse, or use in unsuitable conditions or in environments not described in product catalogs or manuals, or in any separately agreed-upon specifications
2. Causes not attributable to the delivered product itself
3. Modifications or repairs not performed by Yaskawa
4. Abuse of the delivered product in a manner in which it was not originally intended
5. Causes that were not foreseeable with the scientific and technological understanding at the time of shipment from Yaskawa
6. Events for which Yaskawa is not responsible, such as natural or human-made disasters

(2) Limitations of Liability

1. Yaskawa shall in no event be responsible for any damage or loss of opportunity to the customer that arises due to failure of the delivered product.
2. Yaskawa shall not be responsible for any programs (including parameter settings) or the results of program execution of the programs provided by the user or by a third party for use with programmable Yaskawa products.
3. The information described in product catalogs or manuals is provided for the purpose of the customer purchasing the appropriate product for the intended application. The use thereof does not guarantee that there are no infringements of intellectual property rights or other proprietary rights of Yaskawa or third parties, nor does it construe a license.
4. Yaskawa shall not be responsible for any damage arising from infringements of intellectual property rights or other proprietary rights of third parties as a result of using the information described in catalogs or manuals.

(3) Suitability for Use



1. It is the customer's responsibility to confirm conformity with any standards, codes, or regulations that apply if the Yaskawa product is used in combination with any other products.
2. The customer must confirm that the Yaskawa product is suitable for the systems, machines, and equipment used by the customer.
3. Consult with Yaskawa to determine whether use in the following applications is acceptable. If use in the application is acceptable, use the product with extra allowance in ratings and specifications, and provide safety measures to minimize hazards in the event of failure.
 - Outdoor use, use involving potential chemical contamination or electrical interference, or use in conditions or environments not described in product catalogs or manuals
 - Nuclear energy control systems, combustion systems, railroad systems, aviation systems, vehicle systems, medical equipment, amusement machines, and installations subject to separate industry or government regulations
 - Systems, machines, and equipment that may present a risk to life or property
 - Systems that require a high degree of reliability, such as systems that supply gas, water, or electricity, or systems that operate continuously 24 hours a day
 - Other systems that require a similar high degree of safety
4. Never use the product for an application involving serious risk to life or property without first ensuring that the system is designed to secure the required level of safety with risk warnings and redundancy, and that the Yaskawa product is properly rated and installed.
5. The circuit examples and other application examples described in product catalogs and manuals are for reference. Check the functionality and safety of the actual devices and equipment to be used before using the product.
6. Read and understand all use prohibitions and precautions, and operate the Yaskawa product correctly to prevent accidental harm to third parties.

(4) Specifications Change

The names, specifications, appearance, and accessories of products in product catalogs and manuals may be changed at any time based on improvements and other reasons. The next editions of the revised catalogs or manuals will be published with updated code numbers. Consult with your Yaskawa representative to confirm the actual specifications before purchasing a product.

Harmonized Standards

■ North American Safety Standards (UL)

Name (Model)	UL Standards (UL File No.)	Mark
SERVOPACK (SGDV-□□□H, -□□□J), Converter (SGDV-COA)	UL508C (E147823)	
Servomotor (SGMVV)	UL1004 (E165827)	

■ European Directives



Name (Model)	European Directives	Harmonized Standards
SERVOPACK (SGDV-□□□H, -□□□J), Converter (SGDV-COA)	Machinery Directive 2006/42/EC	EN ISO13849-1: 2008, EN 954-1
	EMC Directive 2004/108/EC	EN 55011 group 1 class A, EN 61000-6-2, EN 61800-3
	Low Voltage Directive 2006/95/EC	EN 50178, EN 61800-5-1
Servomotor (SGMVV)	EMC Directive 2004/108/EC	EN 55011 group 1 class A, EN 61000-6-2, EN 61800-3
	Low Voltage Directive 2006/95/EC	EN 60034-1, EN 60034-5/A1

■ Safety Standards



Name (Model)	Safety Standards	Standards
SERVOPACK (SGDV-□□□H, -□□□J), Converter (SGDV-COA)	Safety of Machinery	EN ISO13849-1: 2008, EN 954-1, IEC 60204-1
	Functional Safety	IEC 61508 series, IEC 62061, IEC 61800-5-2
	EMC	IEC 61326-3-1

■ Safe Performance

Items	Standards	Performance Level
Safety Integrity Level	IEC 61508	SIL2
	IEC 62061	SILCL2
Probability of Dangerous Failure per Hour	IEC 61508, IEC 62061	PFH \Leftarrow 1.7×10^{-9} [1/h] (0.17% of SIL2)
Category	EN 954-1	Category 3
Performance Level	EN ISO 13849-1	PL d (Category 3)
Mean Time to Dangerous Failure of Each Channel	EN ISO 13849-1	MTTFd: High
Average Diagnostic Coverage	EN ISO 13849-1	DCave: Low
Stop Category	IEC 60204-1	Stop category 0
Safety Function	IEC 61800-5-2	STO
Proof test Interval	IEC 61508	10 years

Contents

About this Manual	iii
Safety Precautions	viii
Warranty	xv
Harmonized Standards	xvii
1 Overview of Setup	1-1
2 Installation	2-1
2.1 Installation Environment and Applicable Standards	2-2
2.1.1 Servomotor Installation Environment	2-2
2.1.2 SERVOPACK and Converter Installation Environment	2-3
2.1.3 Installation Conditions for Applicable Standards	2-4
2.2 Servomotor Installation	2-5
2.2.1 Orientation	2-5
2.2.2 Installation Standards	2-5
2.2.3 Connecting Servomotor to Machine	2-6
2.2.4 Protective Structure	2-6
2.2.5 Other Precautions	2-7
2.3 SERVOPACK and Converter Installation	2-11
2.3.1 Orientation	2-11
2.3.2 Installation Standards	2-12
2.4 EMC Installation Conditions	2-13
2.4.1 SGD V-□□□□01A (Analog Pulse Model)	2-13
2.4.2 SGD V-□□□□11A (M-II Model)	2-17
2.4.3 SGD V-□□□□21A (M-III Model)	2-21
2.4.4 SGD V-□□□□E1A (Command Option Attachable Type)	2-25
2.4.5 Other Precautions	2-25
3 Wiring and Connection	3-1
3.1 Precautions for Wiring	3-2
3.2 Discharging Time of the Main Circuit's Capacitor	3-4
3.3 System Configuration Diagram	3-5
3.3.1 SGD V-□□□□01A SERVOPACK (Analog Pulse Model)	3-5
3.3.2 SGD V-□□□□11A SERVOPACK (M-II Model)	3-7
3.3.3 SGD V-□□□□21A SERVOPACK (M-III Model)	3-9
3.3.4 SGD V-□□□□E1A SERVOPACK (Command Option Attachable Type)	3-11
3.4 Main Circuit Wiring	3-15
3.4.1 Names and Functions of Main Circuit Terminals	3-15
3.4.2 Connecting the Connectors	3-18
3.4.3 Interconnecting Terminals	3-19
3.4.4 Main Circuit Wires	3-21
3.4.5 Typical Main Circuit Wiring Examples	3-34

3.5	Selecting and Connecting a Regenerative Resistor Unit	3-38
3.5.1	Selecting a Regenerative Resistor Unit	3-38
3.5.2	Connecting a Regenerative Resistor Unit	3-39
3.5.3	Setting Regenerative Resistor Capacity	3-40
3.5.4	Installation Standards	3-40
3.6	Selecting and Connecting a Dynamic Brake Unit	3-41
3.6.1	Selection	3-41
3.6.2	Connections	3-41
3.6.3	Installation Standards	3-44
4	Safety Function	4-1
4.1	Outline	4-2
4.2	Hard Wire Base Block (HWBB) Function	4-3
4.3	Safety Function Signal (CN8) Names and Functions	4-4
4.4	Precautions When Not Using the Safety Function	4-5
4.5	Connecting a Safety Function Device	4-5
5	Trial Operation (Checking Servomotor Operation)	5-1
5.1	Outline	5-2
5.2	Inspection and Checking before Trial Operation	5-3
5.3	JOG Operation Using a Panel Operator	5-6
5.4	JOG Operation Using a Digital Operator	5-8
5.5	JOG Operation Using SigmaWin+	5-11
Revision History		

Overview of Setup

This chapter describes how to set up the servo drives.

This chapter describes the flow of the setup procedure from installation until a JOG operation. A panel operator, a digital operator, and SigmaWin+, (which is an engineering tool that can be used with a PC) are available to set up a servo drive. The panel operator is included with the SERVOPACK of analog pulse models, and the digital operator and SigmaWin+ are sold separately.

 CAUTION
<ul style="list-style-type: none"> An alarm or warning may be generated if communications are executed with the host controller during operation using SigmaWin+ or the digital operator. If an alarm or warning is generated, the process currently being executed may be aborted and the system may stop.

	Be sure to read 5.2 <i>Inspection and Checking before Trial Operation.</i>
IMPORTANT	

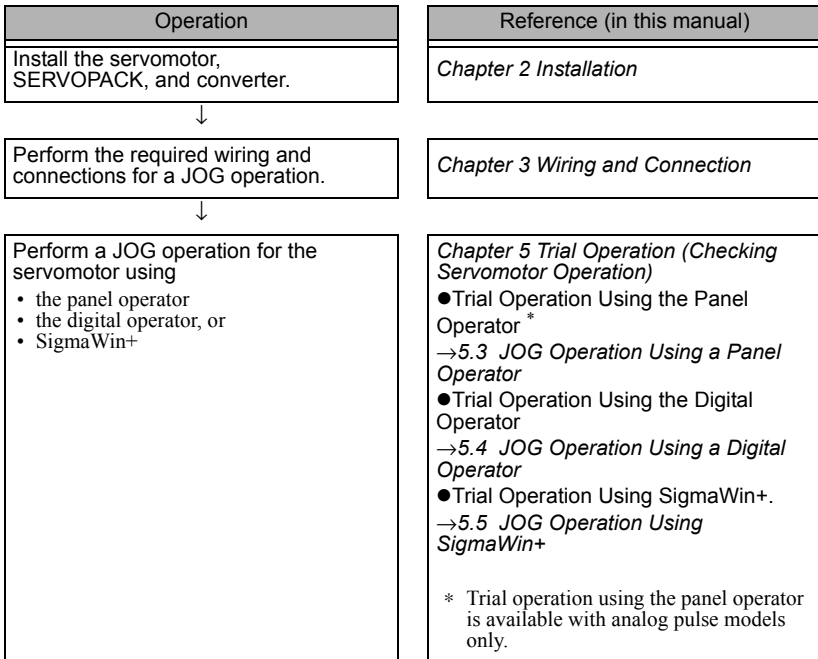

Installation

This chapter describes how to install the servomotor, the SERVOPACK, and the converter.

2.1	Installation Environment and Applicable Standards	2-2
2.1.1	Servomotor Installation Environment	2-2
2.1.2	SERVOPACK and Converter Installation Environment	2-3
2.1.3	Installation Conditions for Applicable Standards	2-4
2.2	Servomotor Installation	2-5
2.2.1	Orientation	2-5
2.2.2	Installation Standards	2-5
2.2.3	Connecting Servomotor to Machine	2-6
2.2.4	Protective Structure	2-6
2.2.5	Other Precautions	2-7
2.3	SERVOPACK and Converter Installation	2-11
2.3.1	Orientation	2-11
2.3.2	Installation Standards	2-12
2.4	EMC Installation Conditions	2-13
2.4.1	SGDV-□□□□01A (Analog Pulse Model)	2-13
2.4.2	SGDV-□□□□11A (M-II Model)	2-17
2.4.3	SGDV-□□□□21A (M-III Model)	2-21
2.4.4	SGDV-□□□□E1A (Command Option Attachable Type)	2-25
2.4.5	Other Precautions	2-25

2.1 Installation Environment and Applicable Standards

The installation environment and the applicable standards for servomotors and SERVOPACKs and converters are described in this section.

2.1.1 Servomotor Installation Environment

- Ambient temperature: 0 to 40°C
- Ambient humidity: 20 to 80% RH (with no condensation)
- Altitude: 1, 000 m or less
- Vibration resistance: The servomotor will withstand the following vibration acceleration in three directions: vertical, side to side, and front to back.
Vibration Acceleration at Flange: 24.5 m/s^2

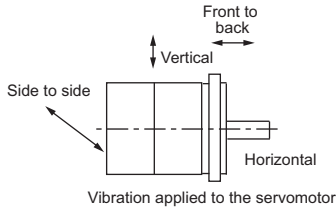

- Shock resistance: The impact resistance for vertical impact when the shaft of the servomotor is connected to a horizontal axis is as follows:
 - Impact acceleration: 490 m/s^2
 - Number of impacts: 2

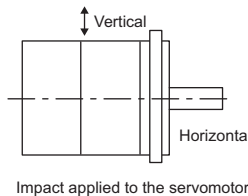

■ Installation site: An environment that satisfies the following conditions

- Indoors and free of corrosive or explosive gases
- Well-ventilated and free of dust and moisture
- Facilitates inspection and cleaning
- Free of high magnetic field

2.1.2 SERVOPACK and Converter Installation Environment

- Surrounding air temperature: 0 to 55°C
- Ambient humidity: 90% RH or less (with no condensation)
- Altitude: 1,000 m or less
- Vibration resistance: 4.9 m/s²
- Shock resistance: 19.6 m/s²

■ Installation Precautions

- Mounting in a Control Panel

To prevent the temperature around the SERVOPACK and the converter from exceeding 55°C, take into account the size of the control panel, the layout of the SERVOPACK and the converter, and the cooling method. For details, refer to 2.3 *SERVOPACK and Converter Installation*.

- Mounting Near a Heating Unit

To prevent the temperature around the SERVOPACK and the converter from exceeding 55°C, suppress radiant heat from the heating unit and temperature rise due to convection.

- Mounting Near a Vibration Source

To prevent vibration from being transmitted to the SERVOPACK and the converter, install a vibration isolator underneath the SERVOPACK and the converter.

- Mounting to a Location Exposed to Corrosive Gas

Take measures to prevent exposure to corrosive gas. Corrosive gases will not immediately affect the SERVOPACK and the converter, but will eventually cause electronic components and contactor-related devices to malfunction.

2.1.3 Installation Conditions for Applicable Standards

- Other Locations

Do not mount the SERVOPACK and the converter in locations subject to high temperatures, high humidity, dripping water, cutting oil, dust, iron filings, or radiation.

<Note>

When storing the SERVOPACK and the converter with the power OFF, store it in an environment with the following temperature and humidity:

- -20 to +85°C, 90% RH or less. (with no condensation)

2.1.3 Installation Conditions for Applicable Standards

Applicable Standards	UL508C EN 50178, EN 55011 group1 classA, EN 61000-6-2, EN 61800-3, EN 61800-5-1, EN 954-1, IEC 61508-1 to 4
Operating Conditions	Overvoltage Category: III Pollution degree: 2 Protection class: IP10
Installation Conditions	UL Standard and Low Voltage Directive: Satisfy the conditions outlined in <i>AC SERVOPACK and Converter ΣV Series Safety Precautions For Use with Large-Capacity Models</i> (manual no.: TOBP C710829 07) EMC Directive: Certification is required after installation in the user's machine under the conditions outlined in <i>2.4 EMC Installation Conditions</i> of this manual.

2.2 Servomotor Installation

2.2.1 Orientation

The mounting orientation depends on the method that is used to install the servomotor. The allowable mounting orientations are given in the follow table.

Mounting Method	Holding Brake	Allowable Mounting Orientations
Flange-mounted	No	Horizontal or vertical
	Yes	
Foot-mounted	No	Horizontal
	Yes	

2.2.2 Installation Standards

The motor rated specifications (rated output, rated torque, and rated speed) are the continuous allowable values at an ambient temperature of 40°C when servomotors are installed with heat sinks.

For more information on heat sinks, refer to *Large-Capacity Σ -V Series Product Catalog*.

If the heat sink is small, the temperature of the servomotor can increase greatly. If the servomotor is surrounded by a case or if there are objects that generate heat near the servomotor, the temperature of the servomotor can increase greatly.

Always check the temperature of the servomotor on the actual equipment before actual operation.

2.2.3 Connecting Servomotor to Machine

The end of the motor shaft is coated with anticorrosive paint. Thoroughly remove the paint before installation.

Align the shaft of the servomotor with the shaft of the machine, and then couple the shafts. Install the servomotor so that alignment accuracy falls within the following range. Vibration will damage the bearings or encoders if the shafts are not properly aligned.

Do not allow direct impact to be applied to the shafts when installing the coupling as the encoder mounted on the opposite end of the shaft may be damaged.

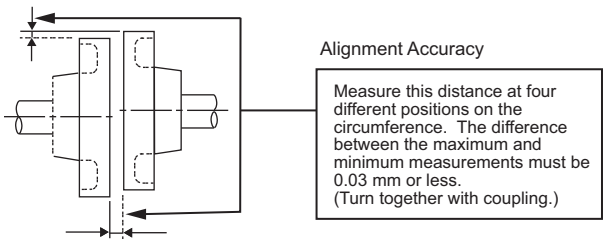

2.2.4 Protective Structure

The servomotor's protective structure* is totally enclosed and cooled separately with an IP44.

* Except through shaft section. The protective structure specifications can be satisfied only when using a specified cable.

When the through shaft section is subject to oil exposure, refer to 2.2.5 *Other Precautions*.

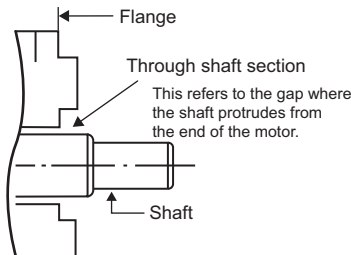

2.2.5 Other Precautions

■ Handling Oil and Water

If the servomotor is used in a location that is subject to water or oil mist, use a servomotor with an oil seal to seal the through shaft section. Precautions on using a servomotor with an oil seal are described below.

- Put the oil surface under the oil seal lip.
- Use an oil seal in favorably lubricated condition.
- When using a servomotor with its shaft upward direction, be sure that oil will not stay in the oil seal lips.

■ Cable Stress

Make sure there is no bending or tension on the cables themselves, the connections, or the cable lead inlets.

Be especially careful to wire encoder cables so that they are not subject to stress because the core wires of encoder cables are very thin at only 0.2 to 0.3 mm².

■ Connectors

Observe the following precautions:

- When you connect the cables to the servomotor, connect the servomotor's main circuit cable first. If you connect the encoder cable first, the encoder may be damaged due to the difference in electrical potential from the FG.
- Make sure there is no foreign matters such as dust and metal chips in the connector before connecting.
- Do not apply shock to connectors. Otherwise, they may be damaged.
- Before you connect the wires, make sure that there are no mistakes in the wiring.
- Be sure not to apply stress on the connector. The connector may be damaged by stress.
- If you move the servomotor while the cables are connected, always hold onto the main body of the servomotor. If you lift the servomotor by the cables when you move it, the terminals may be damaged or the cables may be broken.

■ Radial and Thrust loads

Design the mechanical system so thrust and radial loads applied to the servomotor shaft end during operation fall within the allowable ranges of each motor. For the allowable ranges, refer to *Large-Capacity Σ-V Series Product Catalog*.

■ Wiring the Motor Terminal Box

- Connect the servomotor power lines (U, V, and W) to the servomotor terminal block (M10) in the servomotor terminal box. Connect the ground wire to the ground bolt (M10) in the terminal box.
 - The servomotor has a built-in thermostat. Wire the thermostat leads (1, 1b) to the terminal block (M4) in the servomotor's terminal box.
- Terminal Box

Motor Capacity	22 kW to 37 kW (1500 min ⁻¹), 22 kW (800 min ⁻¹)	45 kW to 55 kW (1500 min ⁻¹), 30 kW to 45 kW (800 min ⁻¹)																														
Motor without Brake (Units: mm)	<table border="1"> <thead> <tr> <th>Symbol</th> <th>Terminal</th> <th>Terminal Screw</th> </tr> </thead> <tbody> <tr> <td>U,V,W</td> <td>Motor</td> <td>M10</td> </tr> <tr> <td>⊕</td> <td>Ground</td> <td>M10</td> </tr> <tr> <td>1,1b</td> <td>Thermostat</td> <td>M4</td> </tr> </tbody> </table>	Symbol	Terminal	Terminal Screw	U,V,W	Motor	M10	⊕	Ground	M10	1,1b	Thermostat	M4	<table border="1"> <thead> <tr> <th>Symbol</th> <th>Terminal</th> <th>Terminal Screw</th> </tr> </thead> <tbody> <tr> <td>U,V,W</td> <td>Motor</td> <td>M10</td> </tr> <tr> <td>⊕</td> <td>Ground</td> <td>M10</td> </tr> <tr> <td>1,1b</td> <td>Thermostat</td> <td>M4</td> </tr> </tbody> </table>	Symbol	Terminal	Terminal Screw	U,V,W	Motor	M10	⊕	Ground	M10	1,1b	Thermostat	M4						
	Symbol	Terminal	Terminal Screw																													
U,V,W	Motor	M10																														
⊕	Ground	M10																														
1,1b	Thermostat	M4																														
Symbol	Terminal	Terminal Screw																														
U,V,W	Motor	M10																														
⊕	Ground	M10																														
1,1b	Thermostat	M4																														
Motor with Brake (Units: mm)	<table border="1"> <thead> <tr> <th>Symbol</th> <th>Terminal</th> <th>Terminal Screw</th> </tr> </thead> <tbody> <tr> <td>U,V,W</td> <td>Motor</td> <td>M10</td> </tr> <tr> <td>⊕</td> <td>Ground</td> <td>M10</td> </tr> <tr> <td>1,1b</td> <td>Thermostat</td> <td>M4</td> </tr> <tr> <td>A,B</td> <td>Brake</td> <td>M4</td> </tr> </tbody> </table>	Symbol	Terminal	Terminal Screw	U,V,W	Motor	M10	⊕	Ground	M10	1,1b	Thermostat	M4	A,B	Brake	M4	<table border="1"> <thead> <tr> <th>Symbol</th> <th>Terminal</th> <th>Terminal Screw</th> </tr> </thead> <tbody> <tr> <td>U,V,W</td> <td>Motor</td> <td>M10</td> </tr> <tr> <td>⊕</td> <td>Ground</td> <td>M10</td> </tr> <tr> <td>1,1b</td> <td>Thermostat</td> <td>M4</td> </tr> <tr> <td>A,B</td> <td>Brake</td> <td>M4</td> </tr> </tbody> </table>	Symbol	Terminal	Terminal Screw	U,V,W	Motor	M10	⊕	Ground	M10	1,1b	Thermostat	M4	A,B	Brake	M4
	Symbol	Terminal	Terminal Screw																													
U,V,W	Motor	M10																														
⊕	Ground	M10																														
1,1b	Thermostat	M4																														
A,B	Brake	M4																														
Symbol	Terminal	Terminal Screw																														
U,V,W	Motor	M10																														
⊕	Ground	M10																														
1,1b	Thermostat	M4																														
A,B	Brake	M4																														

■ Protecting the Servomotor

⚠ WARNING

- Be sure to connect the servomotor's built-in thermostat to the host controller or to the main circuit magnetic contactor's operation circuit. Failure to observe this warning may result in injury, fire, or damage to the product.
- Usage Example 1:
In this example, the output signal from the thermostat is received by the host controller if the thermostat is activated and the host controller turns OFF the servo.

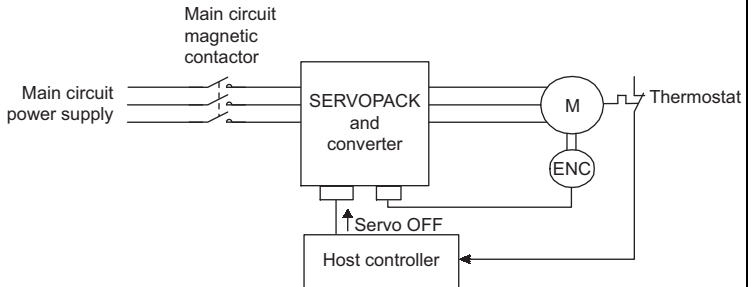

- Usage Example 2:
In this example, the main circuit magnetic contactor's operation circuit is activated or the output signal from the thermostat is received by the host controller if the thermostat is activated and the main circuit magnetic contactor is turned OFF.

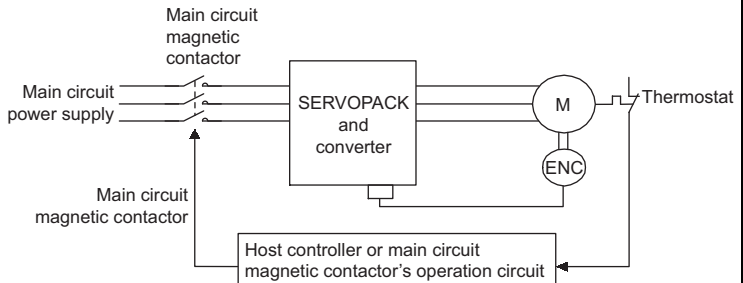

■ Wiring the Servomotor Fan

Wire the servomotor fan leads U(A), V(B), and W(C) so that the direction of air flows according to the following diagram. If the air flows in the opposite direction, change the wiring of any of the two phases U, V, and W.

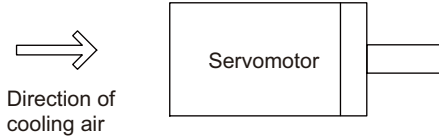

■ Protecting the Servomotor Fan

• Protection from Overheating

The cooling fan of the servomotor has a built-in thermal protector, and the fan stops automatically when excessive overheating occurs.

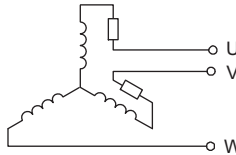

• Protection from Abnormal Current

Install a 2-A molded case circuit breaker on the servomotor fan cable.

■ Servomotor Fan Installation Space

To maximize the cooling capacity of the servomotor fan, install the fan at least 200 mm from the inlet side of the servomotor as shown in the following diagram.

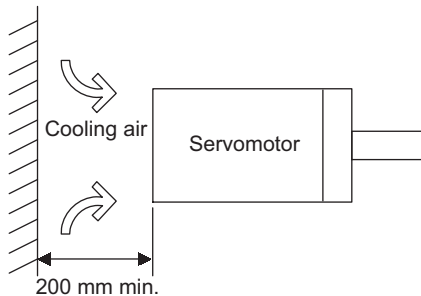

2.3 SERVOPACK and Converter Installation

2.3.1 Orientation

The SERVOPACK and the converter are available in models that are base-mounted, and models that are duct-ventilated. In any case, mount the SERVOPACK and the converter with a vertical orientation.

Firmly secure the SERVOPACK and the converter to the mounting surface, using the four mounting holes on each.

- Base-mounted

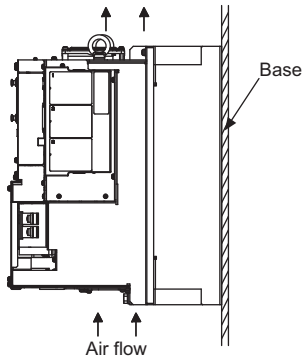

- Duct-ventilated

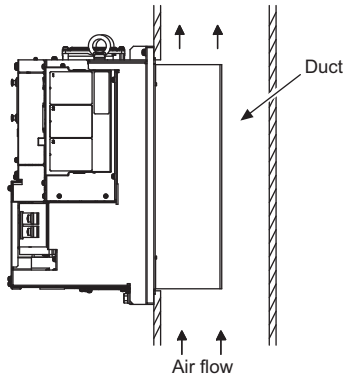

2.3.2 Installation Standards

Observe the standards for mounting SERVOPACKs and converters in control panels, including those for the mounting SERVOPACKs and converters side by side in one control panel as shown in the following illustration.

- **SERVOPACK and Converter Mounting Orientation**

Mount the SERVOPACK and converter vertically to the wall, with the front panel (the side with the panel operator display) facing out.

- **SERVOPACK and Converter Layout and Spacing**

Place the SERVOPACK on the right side of the converter. Separate the SERVOPACK and the converter by 5 mm when you install them.

- **Cooling**

Refer to the following diagram and leave sufficient space for cooling by fans and natural convection.

- **Mounting SERVOPACKs and Converters Side by Side in a Control Panel**

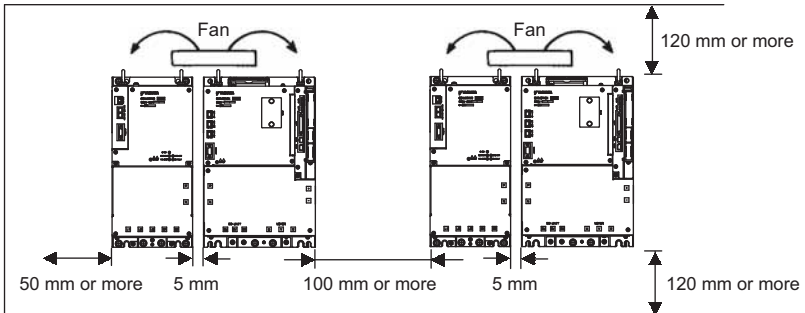

Also install cooling fans above the SERVOPACKs and converters to disperse local pockets of warmer air around the SERVOPACK and converters.

- **Inside the Control Panel**

The conditions inside the control panel should be the same as the environmental conditions of the SERVOPACK and the converters. Refer to *2.1.2 SERVOPACK and Converter Installation Environment*.

2.4 EMC Installation Conditions

This section describes the recommended installation conditions that satisfy EMC guidelines for each model of the SERVOPACK and converter.

The EMC installation conditions that are described in this section were used when Yaskawa products passed the EMC conformance testing. The actual EMC level will depend on the actual device configuration, wiring, and other conditions. However, because this product is built-in, check that the conditions are still met after being installed in the user's product.

2.4.1 SGDV-□□□□01A (Analog Pulse Model)

■ Three-phase 200 V

- SERVOPACK: SGDV-□□□□H01A (□□□ = 121, 161, 201)
- Converter: SGDV-COA□□AA (□□ = 2B, 3G)

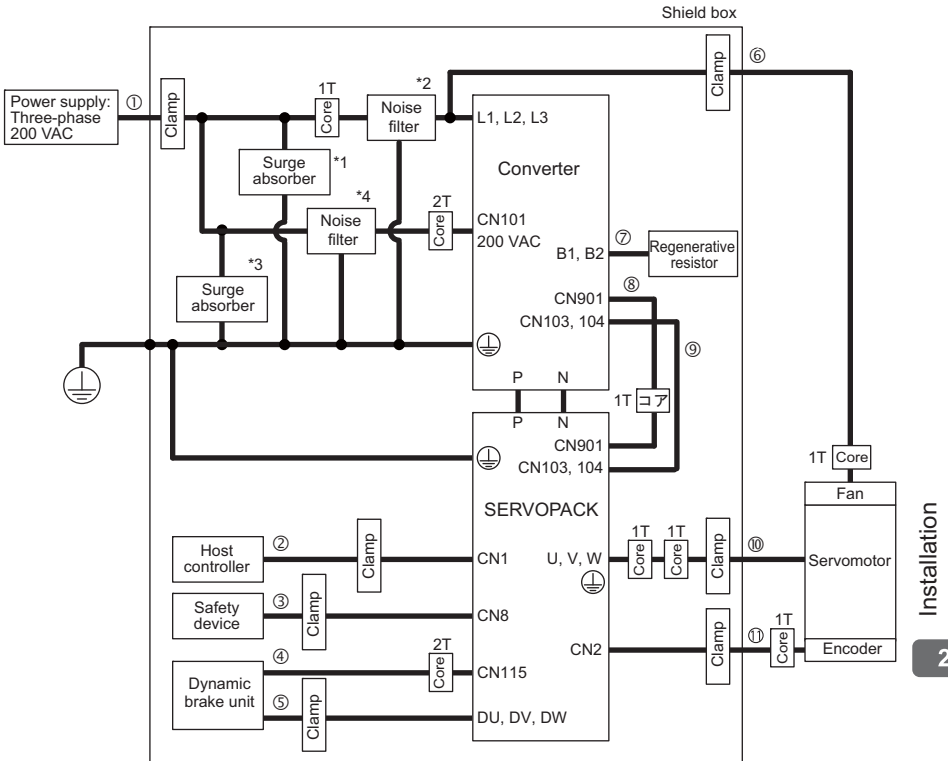

Note: 1T: 1 turn

2T: 2 turns

For details, refer to 2.4.5 *Other Precautions*.

2 Installation

2.4.1 SGDV-□□□□01A (Analog Pulse Model)

Symbol	Cable Name	Specification
①	Main circuit cable	Shield cable
②	I/O signal cable	Shield cable
③	Safety signal cable	Shield cable
④	Dynamic brake unit signal cable	Non-shield cable
⑤	Dynamic brake unit power cable	Non-shield cable
⑥	Motor fan cable	Shield cable
⑦	Regenerative resistor unit cable	Non-shield cable
⑧	I/O signal connection cable	Shield cable
⑨	24 VDC control power cable	Non-shield cable
⑩	Motor main circuit cable	Shield cable
⑪	Encoder cable	Shield cable

- *1. Surge absorber model: LT-C32G801WS (manufactured by Soshin Electric Co., Ltd.)
- *2. The noise filter differs in accordance with the converter used.

Combination of SERVOPACK and Converter		Noise Filter Model	Manufacturer
SERVOPACK Model: SGDV-	Converter Model: SGDV-COA		
121H	2BAA	HF3150C-UQB	Soshin Electric Co., Ltd.
161H	3GAA	HF3200C-UQB	
201H	3GAA	HF3250C-UQB	

- *3. Surge absorber model: LT-C12G801WS (manufactured by Soshin Electric Co., Ltd.)
- *4. Noise filter model: HF2005A-UP (manufactured by Soshin Electric Co., Ltd.)

■ Three-phase 400 V

- SERVOPACK: SGDV-□□□J01A (□□□ = 750, 101, 131)
- Converter: SGDV-COA□□DA (□□ = 3Z, 5E)

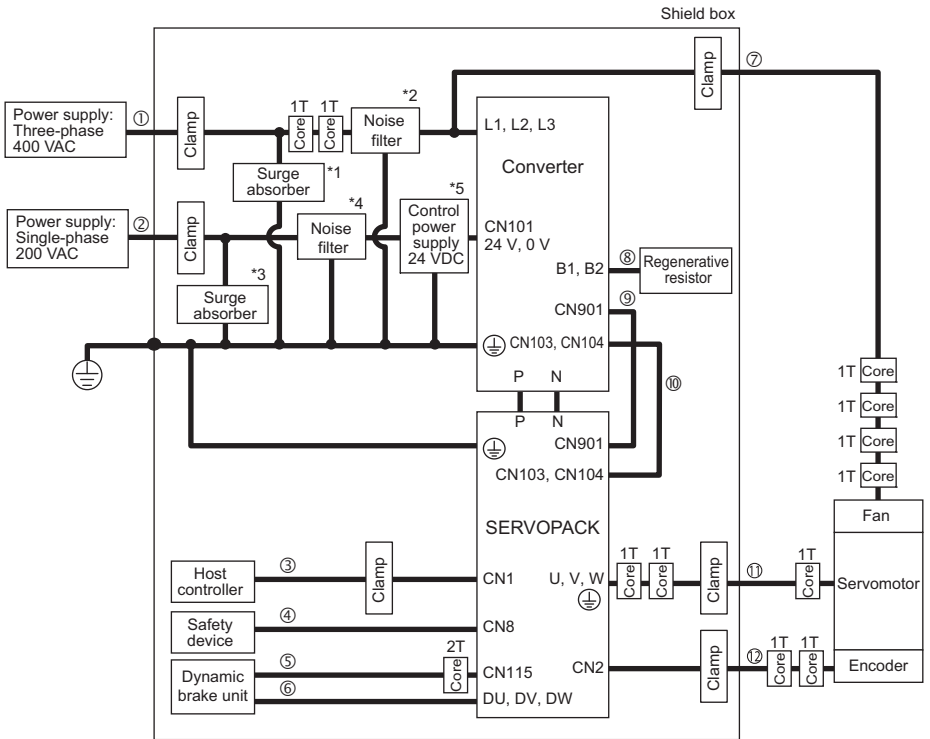

Note: 1T: 1 turn

2T: 2 turns

For details, refer to 2.4.5 Other Precautions.

2 Installation

2.4.1 SGDVB-□□□□01A (Analog Pulse Model)

Symbol	Cable Name	Specification
①	Main circuit cable	Shield cable
②	Control power cable	Shield cable
③	I/O signal cable	Shield cable
④	Safety signal cable	Shield cable
⑤	Dynamic brake unit signal cable	Non-shield cable
⑥	Dynamic brake unit power cable	Non-shield cable
⑦	Motor fan cable	Shield cable
⑧	Regenerative resistor unit cable	Non-shield cable
⑨	I/O signal connection cable	Shield cable
⑩	24 VDC control power cable	Non-shield cable
⑪	Motor main circuit cable	Shield cable
⑫	Encoder cable	Shield cable

- *1. Surge absorber model: LT-C35G102WS (manufactured by Soshin Electric Co., Ltd.)
- *2. The noise filter differs in accordance with the converter used.

Combination of SERVOPACK and Converter		Noise Filter Model	Manufacturer
SERVOPACK Model: SGDVB-	Converter Model: SGDVB-COA		
750J	3ZDA	HF3150C-UQB	Soshin Electric Co., Ltd.
101J	5EDA	HF3150C-UQB	
131J	5EDA	HF3200C-UQB	

- *3. Surge absorber for 200 V: LT-C12G801WS (manufactured by Soshin Electric Co., Ltd.)
- *4. Noise filter for 200 V: HF2005A-UP (manufactured by Soshin Electric Co., Ltd.)
- *5. 24-VDC control power supply: Power supply with double insulation or reinforced insulation that complies with the CE Marking.

2.4.2 SGD V-□□□□11A (M-II Model)

■ Three-phase 200 V

- SERVOPACK: SGD V-□□□H11A (□□□ = 121, 161, 201)
- Converter: SGD V-COA□□AA (□□ = 2B, 3G)

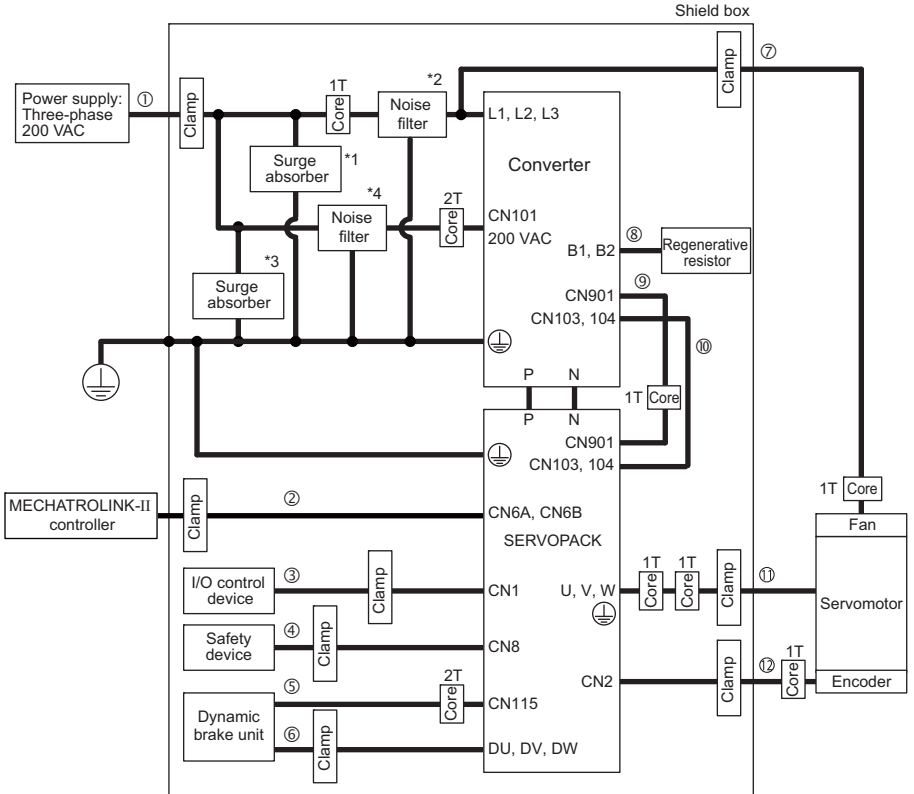

Note: 1T: 1 turn
2T: 2 turns

For details, refer to 2.4.5 Other Precautions.

2 Installation

2.4.2 SGD V-□□□□11A (M-II Model)

Symbol	Cable Name	Specification
①	Main circuit cable	Shield cable
②	MECHATROLINK-II communication cable	Shield cable
③	I/O signal cable	Shield cable
④	Safety signal cable	Shield cable
⑤	Dynamic brake unit signal cable	Non-shield cable
⑥	Dynamic brake unit power cable	Non-shield cable
⑦	Motor fan cable	Shield cable
⑧	Regenerative resistor unit cable	Non-shield cable
⑨	I/O signal connection cable	Shield cable
⑩	24 VDC control power cable	Non-shield cable
⑪	Motor main circuit cable	Shield cable
⑫	Encoder cable	Shield cable

- *1. Surge absorber model: LT-C32G801WS (manufactured by Soshin Electric Co., Ltd.)
- *2. The noise filter differs in accordance with the converter used.

Combination of SERVOPACK and Converter		Noise Filter Model	Manufacturer
SERVOPACK Model: SGD V-	Converter Model: SGD V-COA		
121H	2BAA	HF3150C-UQB	Soshin Electric Co., Ltd.
161H	3GAA	HF3200C-UQB	
201H	3GAA	HF3250C-UQB	

- *3. Surge absorber model: LT-C12G801WS (manufactured by Soshin Electric Co., Ltd.)
- *4. Noise filter model: HF2005A-UP (manufactured by Soshin Electric Co., Ltd.)

■ Three-phase 400 V

- SERVOPACK: SGDV-□□□J11A (□□□ = 750, 101, 131)
- Converter: SGDV-COA□□DA (□□ = 3Z, 5E)

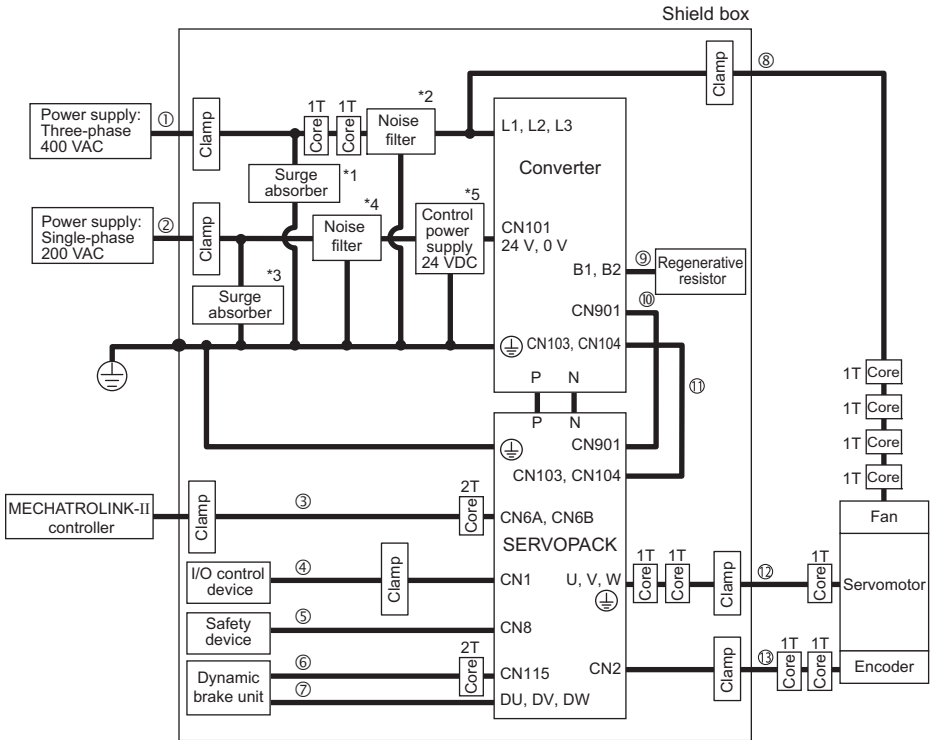

Note: 1T: 1 turn

2T: 2 turns

For details, refer to 2.4.5 Other Precautions.

2 Installation

2.4.2 SGD V-□□□□11A (M-II Model)

Symbol	Cable Name	Specification
①	Main circuit cable	Shield cable
②	Control power cable	Shield cable
③	MECHATROLINK-II communication cable	Shield cable
④	I/O signal cable	Shield cable
⑤	Safety signal cable	Shield cable
⑥	Dynamic brake unit signal cable	Non-shield cable
⑦	Dynamic brake unit power cable	Non-shield cable
⑧	Motor fan cable	Shield cable
⑨	Regenerative resistor unit cable	Non-shield cable
⑩	I/O signal connection cable	Shield cable
⑪	24 VDC control power cable	Non-shield cable
⑫	Motor main circuit cable	Shield cable
⑬	Encoder cable	Shield cable

- *1. Surge absorber model: LT-C35G102WS (manufactured by Soshin Electric Co., Ltd.)
- *2. The noise filter differs in accordance with the converter used.

Combination of SERVOPACK and Converter		Noise Filter Model	Manufacturer
SERVOPACK Model: SGD V-	Converter Model: SGD V-COA		
750J	3ZDA	HF3150C-UQB	Soshin Electric Co., Ltd.
101J	5EDA	HF3150C-UQB	
131J	5EDA	HF3200C-UQB	

- *3. Surge absorber for 200 V: LT-C12G801WS (manufactured by Soshin Electric Co., Ltd.)
- *4. Noise filter for 200 V: HF2005A-UP (manufactured by Soshin Electric Co., Ltd.)
- *5. 24-VDC control power supply: Power supply with double insulation or reinforced insulation that complies with the CE Marking.

2.4.3 SGD V-□□□□21A (M-III Model)

■ Three-phase 200 V

- SERVOPACK: SGD V-□□□□H21A (□□□ = 121, 161, 201)
- Converter: SGD V-COA□□□AA (□□ = 2B, 3G)

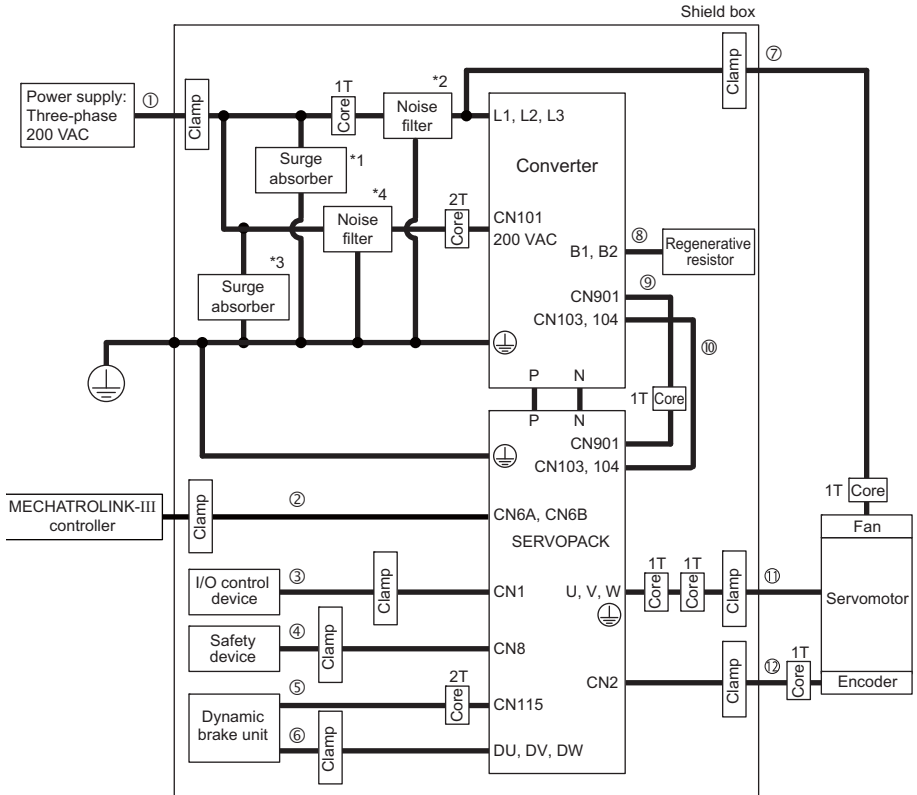

Note: 1T: 1 turn

2T: 2 turns

For details, refer to 2.4.5 Other Precautions.

2.4.3 SGDVB-□□□□21A (M-III Model)

Symbol	Cable Name	Specification
①	Main circuit cable	Shield cable
②	MECHATROLINK-III communication cable	Shield cable
③	I/O signal cable	Shield cable
④	Safety signal cable	Shield cable
⑤	Dynamic brake unit signal cable	Non-shield cable
⑥	Dynamic brake unit power cable	Non-shield cable
⑦	Motor fan cable	Shield cable
⑧	Regenerative resistor unit cable	Non-shield cable
⑨	I/O signal connection cable	Shield cable
⑩	24 VDC control power cable	Non-shield cable
⑪	Motor main circuit cable	Shield cable
⑫	Encoder cable	Shield cable

- *1. Surge absorber model: LT-C32G801WS (manufactured by Soshin Electric Co., Ltd.)
 *2. The noise filter differs in accordance with the converter used.

Combination of SERVOPACK and Converter		Noise Filter Model	Manufacturer
SERVOPACK Model: SGDVB-	Converter Model: SGDVB-COA		
121H	2BAA	HF3150C-UQB	Soshin Electric Co., Ltd.
161H	3GAA	HF3200C-UQB	
201H	3GAA	HF3250C-UQB	

- *3. Surge absorber model: LT-C12G801WS (manufactured by Soshin Electric Co., Ltd.)
 *4. Noise filter model: HF2005A-UP (manufactured by Soshin Electric Co., Ltd.)

■ Three-phase 400 V

- SERVOPACK: SGDV-□□□J21A (□□□ = 750, 101, 131)
- Converter: SGDV-COA□□DA (□□ = 3Z, 5E)

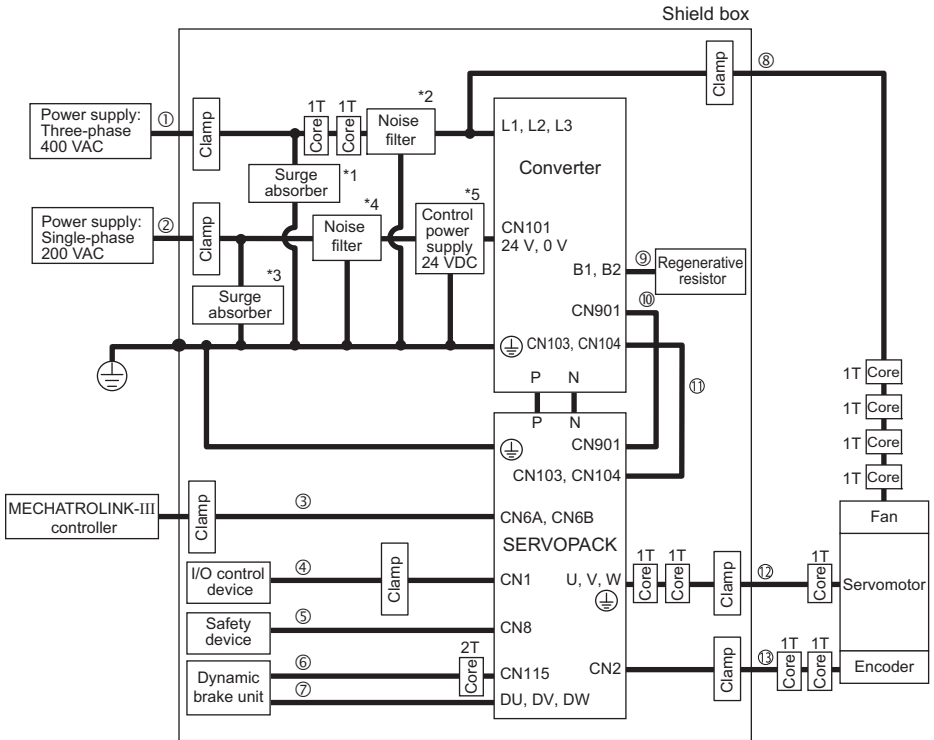

Note: 1T: 1 turn

2T: 2 turns

For details, refer to 2.4.5 Other Precautions.

Symbol	Cable Name	Specification
①	Main circuit cable	Shield cable
②	Control power cable	Shield cable
③	MECHATROLINK-III communication cable	Shield cable
④	I/O signal cable	Shield cable
⑤	Safety signal cable	Shield cable
⑥	Dynamic brake unit signal cable	Non-shield cable
⑦	Dynamic brake unit power cable	Non-shield cable
⑧	Motor fan cable	Shield cable

2.4.3 SGD V-□□□□21A (M-III Model)

(cont'd)

Symbol	Cable Name	Specification
⑨	Regenerative resistor unit cable	Non-shield cable
⑩	I/O signal connection cable	Shield cable
⑪	24 VDC control power cable	Non-shield cable
⑫	Motor main circuit cable	Shield cable
⑬	Encoder cable	Shield cable

- *1. Surge absorber model: LT-C35G102WS (manufactured by Soshin Electric Co., Ltd.)
- *2. The noise filter differs in accordance with the converter used.

Combination of SERVOPACK and Converter		Noise Filter Model	Manufacturer
SERVOPACK Model: SGD V-	Converter Model: SGD V-COA		
750J	3ZDA	HF3150C-UQB	Soshin Electric Co., Ltd.
101J	5EDA	HF3150C-UQB	
131J	5EDA	HF3200C-UQB	

- *3. Surge absorber for 200 V: LT-C12G801WS (manufactured by Soshin Electric Co., Ltd.)
- *4. Noise filter for 200 V: HF2005A-UP (manufactured by Soshin Electric Co., Ltd.)
- *5. 24-VDC control power supply: Power supply with double insulation or reinforced insulation that complies with the CE Marking.

2.4.4 SGD□-□□□□E1A (Command Option Attachable Type)

For SERVOPACKs and converters of command option attachable type, EMC installation conditions may differ depending on the attached option module. For details, refer to the user's manual for each option module.

2.4.5 Other Precautions

■ Attachment Methods of Ferrite Cores

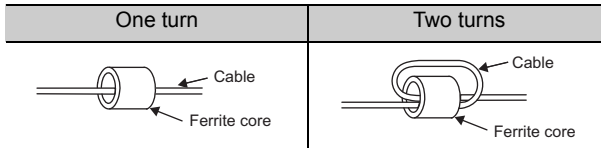

■ Recommended Ferrite Core

- For Three-phase, 200 V

Cable Name	Ferrite Core Model	Manufacturer
Power supply main circuit cable	F11080GB	Hitachi Metals, Ltd.
Servomotor main circuit cable		
Control power cable	ESD-SR-250	NEC TOKIN Corporation
I/O signal connection cable		
Encoder cable		
Dynamic brake unit signal cable		
Motor fan cable		

- For Three-phase, 400 V

Cable Name	Ferrite Core Model	Manufacturer
Power supply main circuit cable	RC5128ZZ	Soshin Electric Co., Ltd.
Servomotor main circuit cable (at servomotor end)		
Servomotor main circuit cable (at SERVOPACK end)	F11080GB	Hitachi Metals, Ltd.
Encoder cable	ESD-SR-250	NEC TOKIN Corporation
Dynamic brake unit signal cable		
Motor fan cable		

■ Fixing the Cable

Fix and ground the cable shield using a piece of conductive metal.

- Example of Cable Clamp

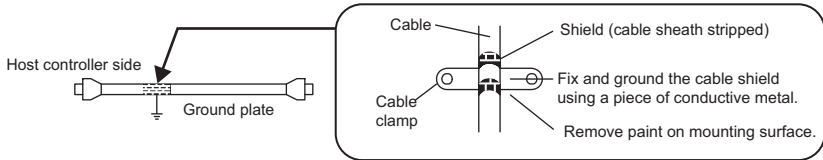

■ Shield Box

A shield box, which is a closed metallic enclosure, is effective as reinforced shielding against electromagnetic interference (EMI) from SERVOPACKs and converters. The structure of the box should allow the main body, door, and cooling unit to be attached to the ground. The box opening should be as small as possible.

Note: Do not connect the digital operator and the analog monitor cable to the SERVOPACK and the converter during operations. Connect them only when the machinery is stopped during maintenance.

Wiring and Connection

This chapter describes how to set up the wiring and connections required for trial operation.

For details, refer to the user's manual for your SERVOPACK.

3.1	Precautions for Wiring	3-2
3.2	Discharging Time of the Main Circuit's Capacitor	3-4
3.3	System Configuration Diagram	3-5
3.3.1	SGDV-□□□□01A SERVOPACK (Analog Pulse Model)	3-5
3.3.2	SGDV-□□□□11A SERVOPACK (M-II Model)	3-7
3.3.3	SGDV-□□□□21A SERVOPACK (M-III Model)	3-9
3.3.4	SGDV-□□□□E1A SERVOPACK (Command Option Attachable Type)	3-11
3.4	Main Circuit Wiring	3-15
3.4.1	Names and Functions of Main Circuit Terminals	3-15
3.4.2	Connecting the Connectors	3-18
3.4.3	Interconnecting Terminals	3-19
3.4.4	Main Circuit Wires	3-21
3.4.5	Typical Main Circuit Wiring Examples	3-34
3.5	Selecting and Connecting a Regenerative Resistor Unit	3-38
3.5.1	Selecting a Regenerative Resistor Unit	3-38
3.5.2	Connecting a Regenerative Resistor Unit	3-39
3.5.3	Setting Regenerative Resistor Capacity	3-40
3.5.4	Installation Standards	3-40
3.6	Selecting and Connecting a Dynamic Brake Unit	3-41
3.6.1	Selection	3-41
3.6.2	Connections	3-41
3.6.3	Installation Standards	3-44

3.1 Precautions for Wiring

CAUTION

- Be sure to wire correctly and securely.
Failure to observe this caution may result in motor overrun, injury, or malfunction.
- Do not connect a commercial power supply to the U, V, or W terminals for the servomotor connection.
Failure to observe this caution may result in injury or fire.
- Securely connect the main circuit terminals.
Failure to observe this caution may result in fire.
- Do not bundle or run the main circuit cables together with the I/O signal cables or the encoder cables in the same duct. Keep them separated by at least 30 cm.
Failure to do so may result in malfunction.
- Use shielded twisted-pair wires or multi-core shielded twisted-pair wires for I/O signal cables and encoder cables.
- Use the bus bars that are included with the converter, and connect the P and N terminals on the SERVOPACK and converter securely.
- The maximum cable length is 3 m for I/O signal cables, 50 m for connection cables for servomotor main circuit or encoder cables, and 10 m for control power supply cables to 400-V converters (+24 V, 0 V).
- Do not touch the power terminals while discharging the main circuit's capacitor, because high voltage may still remain in the SERVOPACK and the converter. For details on the charging time of the main circuit's capacitor, refer to 3.2 *Discharging Time of the Main Circuit's Capacitor*.
Before starting to do wiring or inspections, confirm that the power has been completely discharged (charge indicator: OFF) by using a tester to measure the voltage between the P and N terminals for DC power.
- Be sure to observe the following precautions when wiring the main circuit's terminals and connectors on a SERVOPACK or converter.
 - Do not turn ON the power to a SERVOPACK or converter until all wiring, including the wiring to the main circuit terminal connectors, has been completed.
 - Remove main circuit connectors from the SERVOPACK and the converter before wiring.
 - Insert only one power line per opening in the main circuit terminals.
 - Make sure that no part of the core wire comes into contact with (i.e., short-circuits) adjacent wires.
- Install a battery at either the host controller or the battery unit of the encoder, but not both.
It is dangerous to install batteries at both ends simultaneously, because that sets up a loop circuit between the batteries.
- Always use the specified power supply voltage.
An incorrect voltage may result in fire or malfunction.
- Make sure that the polarity is correct.
Incorrect polarity may cause ruptures or damage.
- Take appropriate measures to ensure that the input power supply is supplied within the specified voltage fluctuation range. Be particularly careful in places where the power supply is unstable.
An incorrect power supply may result in damage to the product.
- Install external breakers or other safety devices against short-circuiting in external wiring.
Failure to observe this caution may result in fire.

 CAUTION

- Take appropriate and sufficient countermeasures for each form of potential interference when installing systems in the following locations.
 - Locations subject to static electricity or other forms of noise
 - Locations subject to strong electromagnetic fields and magnetic fields
 - Locations subject to possible exposure to radioactivity
 - Locations close to power supplies

Failure to observe this caution may result in damage to the product.

- Do not reverse the polarity of the battery when connecting it. Failure to observe this caution may damage the battery, the SERVOPACK, or servomotor, or cause an explosion.
- Wiring or inspection must be performed by a technical expert.
- Use a 24-VDC power supply for the control power of 400-V converter with double insulation or reinforced insulation.

IMPORTANT

- Failures caused by incorrect wiring or wrong voltage application in the brake circuit may damage the equipment or cause an accident resulting in death or injury. Follow the procedures and instructions for wiring and trial operation precisely as described in this manual.
- Leakage current may increase depending on the type of noise filter and the grounding conditions. When using a detector or a breaker for leakage current, select the appropriate one by considering the type of noise filter and the grounding conditions. For details, contact the manufacturer of the noise filter.
- Incorrect wiring or incorrect voltage application to the output circuit may cause short-circuit. The above failures will prevent the holding brake from working, which may damage the machine or cause an accident resulting in death or injury.
- Inverting the polarity of the brake signal (/BK), i.e. positive logic, will prevent the holding brake from working in case of its signal line disconnection. If this setting is absolutely necessary, check the operation and confirm that there are no safety problems.

3.2 Discharging Time of the Main Circuit's Capacitor

The following table shows the discharging time of the main circuit's capacitor.

Input Voltage	Combinations		Discharging Time (min.)
	SERVOPACK Model: SGDV-	Converter Model: SGDV-COA	
Three-phase, 200 VAC	121H	2BAA	20
	161H	3GAA	25
	201H	3GAA	30
Three-phase, 400 VAC	750J	3ZDA	5
	101J	5EDA	10
	131J	5EDA	10

3.3 System Configuration Diagram

3.3.1 SGDV-□□□□01A SERVOPACK (Analog Pulse Model)

■ Three-phase, 200 V

- SERVOPACK: SGDV-□□□□H01A (□□□ = 121, 161, 201)
- Converter: SGDV-COA□□AA (□□ = 2B, 3G)

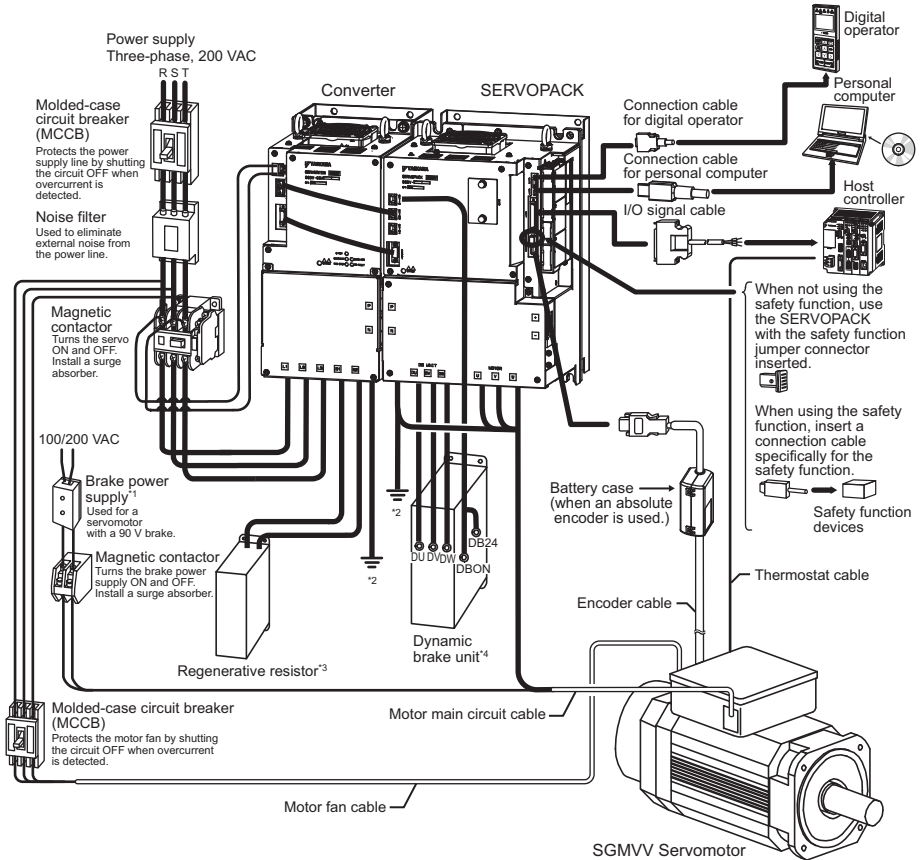

- *1. Use a 24-VDC power supply (not included).
If using a 90-VDC power supply for a brake, however, use one of the following power supplies.
 - For 200-V input voltage: LPSE-2H01-E
 - For 100-V input voltage: LPDE-1H01-E
- *2. For details on grounding, refer to the user's manual for design and maintenance.
- *3. Before connecting an external regenerative resistor, refer to 3.5 *Selecting and Connecting a Regenerative Resistor Unit*.
- *4. For details on the dynamic brake unit, refer to 3.6 *Selecting and Connecting a Dynamic Brake Unit*.

3.3.1 SGDV-□□□□01A SERVOPACK (Analog Pulse Model)

■ Three-phase, 400 V

- SERVOPACK : SGDV-□□□J01A (□□□ = 750, 101, 131)
- Converter : SGDV-COA□□DA (□□ = 3Z, 5E)

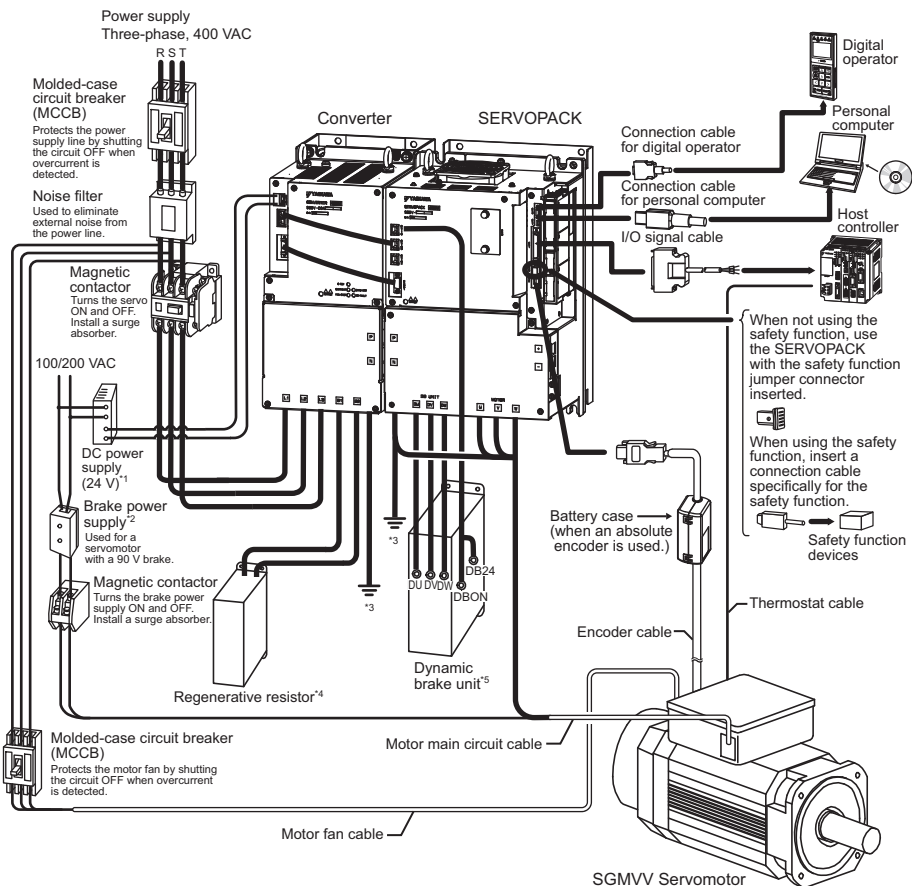

- *1. Use a 24-VDC power supply with double insulation or reinforced insulation (the power supply is not included).
- *2. Use a 24-VDC power supply (not included).
If using a 90-VDC power supply for a brake, however, use one of the following power supplies.
 - For 200-V input voltage: LPSE-2H01-E
 - For 100-V input voltage: LPDE-1H01-E
- *3. For details on grounding, refer to the user's manual for design and maintenance.
- *4. Before connecting an external regenerative resistor, refer to 3.5 *Selecting and Connecting a Regenerative Resistor Unit*.
- *5. For details on the dynamic brake unit, refer to 3.6 *Selecting and Connecting a Dynamic Brake Unit*.

3.3.2 SGD□-□□□□11A SERVOPACK (M-II Model)

■ Three-phase, 200 V

- SERVOPACK: SGD□-□□□□11A (□□□ = 121, 161, 201)
- Converter: SGD□-COA□□□AA (□□ = 2B, 3G)

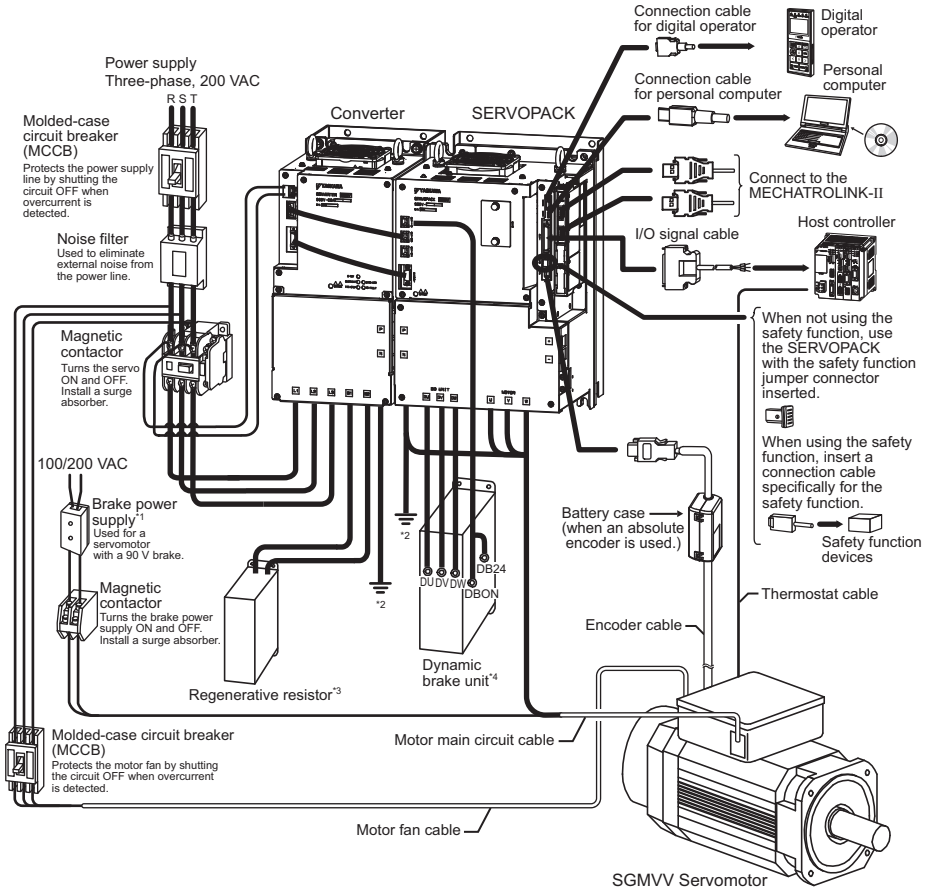

- *1. Use a 24-VDC power supply (not included).
If using a 90-VDC power supply for a brake, however, use one of the following power supplies.
 - For 200-V input voltage: LPSE-2H01-E
 - For 100-V input voltage: LPDE-1H01-E
- *2. For details on grounding, refer to the user's manual for design and maintenance.
- *3. Before connecting an external regenerative resistor, refer to 3.5 *Selecting and Connecting a Regenerative Resistor Unit*.
- *4. For details on the dynamic brake unit, refer to 3.6 *Selecting and Connecting a Dynamic Brake Unit*.

3.3.2 SGDV-□□□□11A SERVOPACK (M-II Model)

■ Three-phase, 400 V

- SERVOPACK : SGDV-□□□□11A (□□□ = 750, 101, 131)
- Converter : SGDV-COA□□DA (□□ = 3Z, 5E)

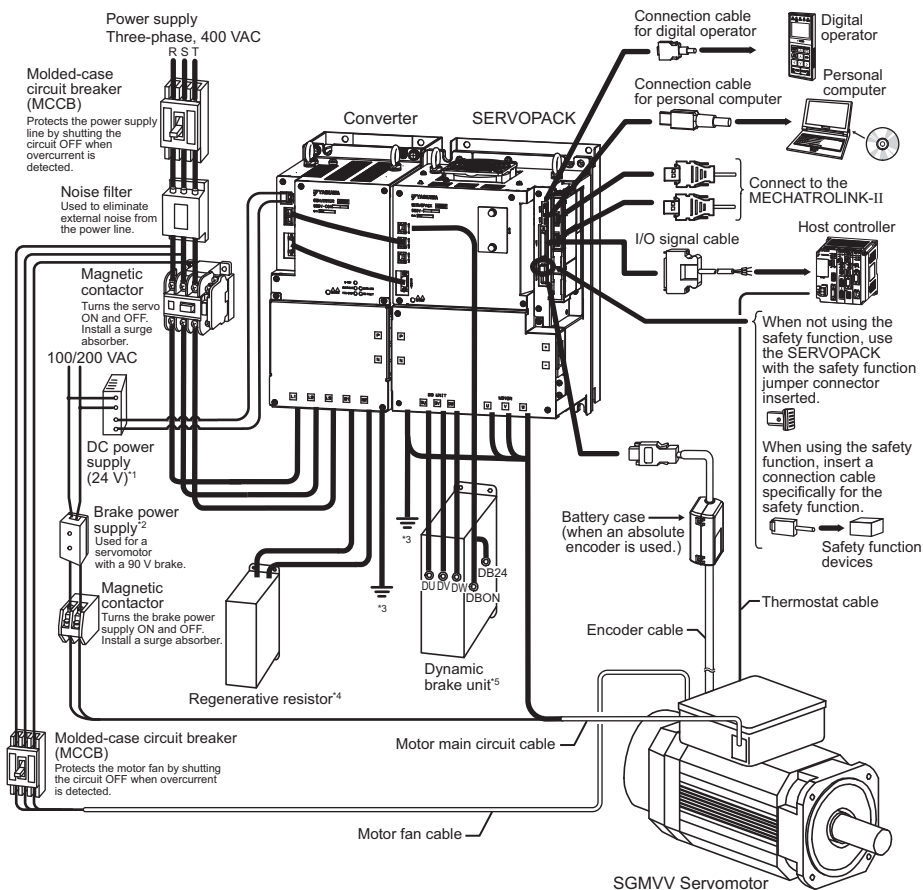

- *1. Use a 24-VDC power supply with double insulation or reinforced insulation (the power supply is not included).
- *2. Use a 24-VDC power supply (not included).
If using a 90-VDC power supply for a brake, however, use one of the following power supplies.
 - For 200-V input voltage: LPSE-2H01-E
 - For 100-V input voltage: LPDE-1H01-E
- *3. For details on grounding, refer to the user's manual for design and maintenance.
- *4. Before connecting an external regenerative resistor, refer to 3.5 *Selecting and Connecting a Regenerative Resistor Unit*.
- *5. For details on the dynamic brake unit, refer to 3.6 *Selecting and Connecting a Dynamic Brake Unit*.

3.3.3 SGD□-□□□□21A SERVOPACK (M-III Model)

■ Three-phase, 200 V

- SERVOPACK : SGD□-□□□□H21A (□□□ = 121, 161, 201)
- Converter : SGD□-COA□□AA (□□ = 2B, 3G)

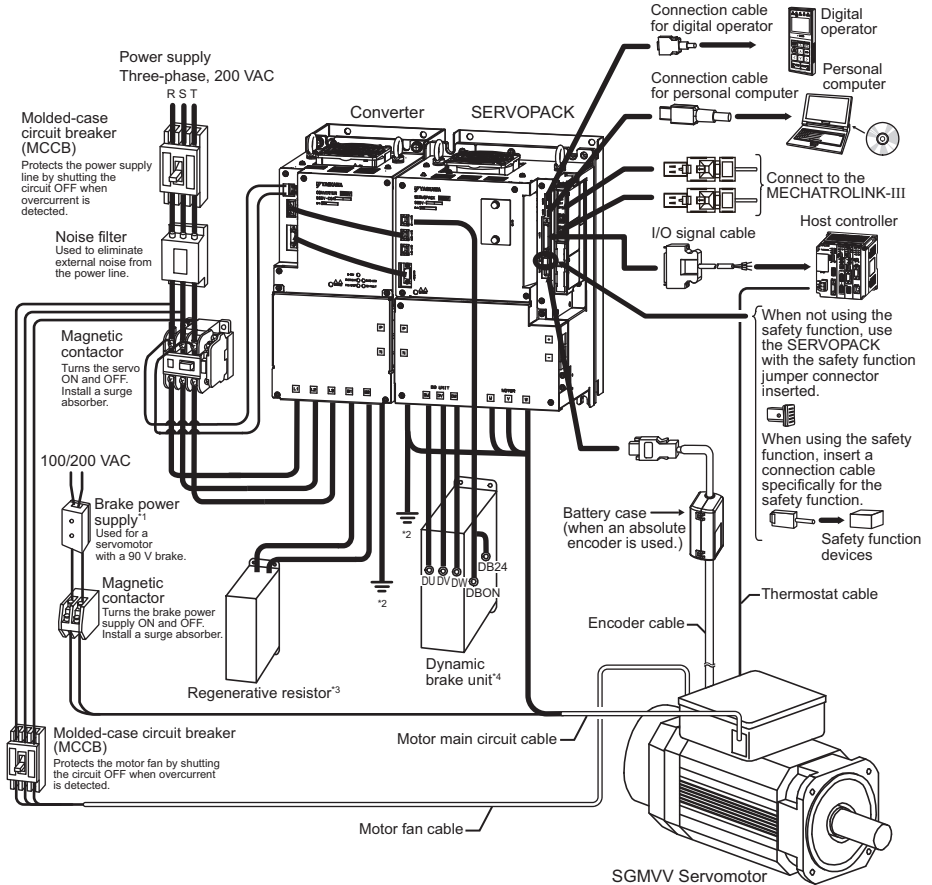

1. Use a 24-VDC power supply (not included).
If using a 90-VDC power supply for a brake, however, use one of the following power supplies.
 - For 200-V input voltage: LPSE-2H01-E
 - For 100-V input voltage: LPDE-1H01-E
2. For details on grounding, refer to the user's manual for design and maintenance.
3. Before connecting an external regenerative resistor, refer to 3.5 *Selecting and Connecting a Regenerative Resistor Unit*.
4. For details on the dynamic brake unit, refer to 3.6 *Selecting and Connecting a Dynamic Brake Unit*.

3.3.3 SGDV-□□□□21A SERVOPACK (M-III Model)

■ Three-phase, 400 V

- SERVOPACK : SGDV-□□□□21A (□□□ = 750, 101, 131)
- Converter : SGDV-COA□□DA (□□ = 3Z, 5E)

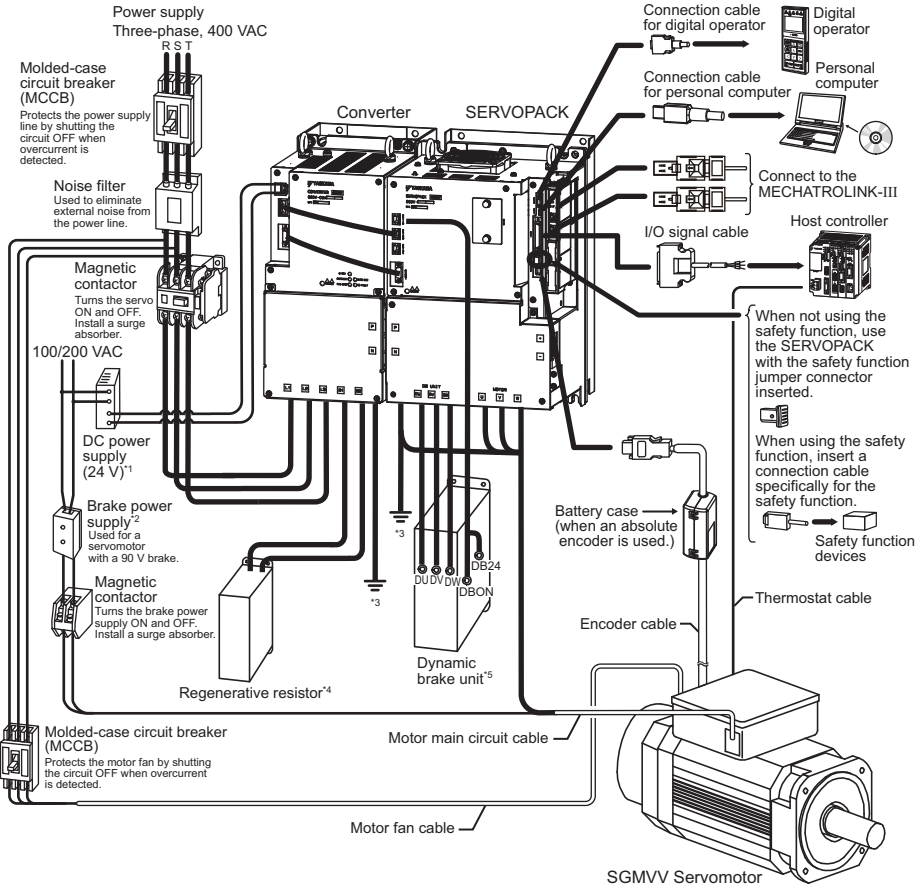

- *1. Use a 24-VDC power supply with double insulation or reinforced insulation (the power supply is not included).
- *2. Use a 24-VDC power supply (not included).
If using a 90-VDC power supply for a brake, however, use one of the following power supplies.
 - For 200-V input voltage: LPSE-2H01-E
 - For 100-V input voltage: LPDE-1H01-E
- *3. For details on grounding, refer to the user's manual for design and maintenance.
- *4. Before connecting an external regenerative resistor, refer to 3.5 *Selecting and Connecting a Regenerative Resistor Unit*.
- *5. For details on the dynamic brake unit, refer to 3.6 *Selecting and Connecting a Dynamic Brake Unit*.

3.3.4 SGDV-□□□□E1A SERVOPACK (Command Option Attachable Type)

■ Three-phase, 200 V

- SERVOPACK: SGDV-□□□□E1A (□□□ = 121, 161, 201)
- Converter: SGDV-COA□□AA (□□ = 2B, 3G)

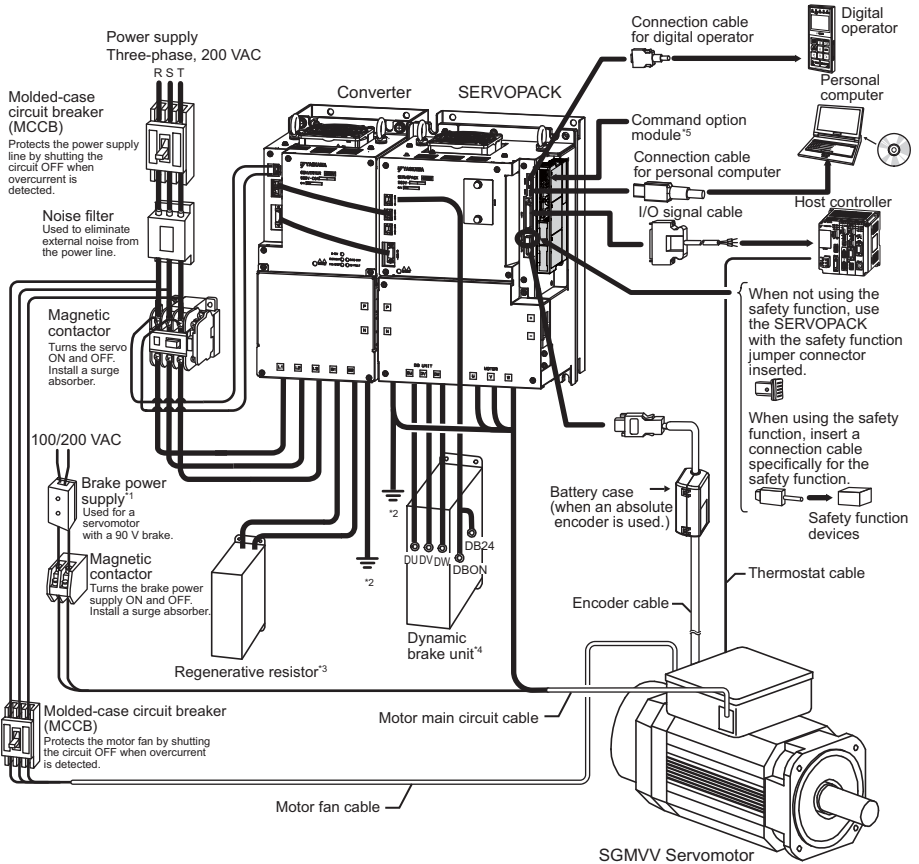

- *1. Use a 24-VDC power supply (not included).
If using a 90-VDC power supply for a brake, however, use one of the following power supplies.
 - For 200-V input voltage: LPSE-2H01-E
 - For 100-V input voltage: LPDE-1H01-E
- *2. For details on grounding, refer to the user's manual for design and maintenance.
- *3. Before connecting an external regenerative resistor, refer to 3.5 *Selecting and Connecting a Regenerative Resistor Unit*.

3.3.4 SGDV-□□□□E1A SERVOPACK (Command Option Attachable Type)

- *4. For details on the dynamic brake unit, refer to *3.6 Selecting and Connecting a Dynamic Brake Unit*.
- *5. For connection to the option module, refer to the user's manual of the corresponding option module.

■ Three-phase, 400 V

- SERVOPACK : SGDV-□□□JE1A (□□□ = 750, 101, 131)
- Converter : SGDV-COA□□DA (□□ = 3Z, 5E)

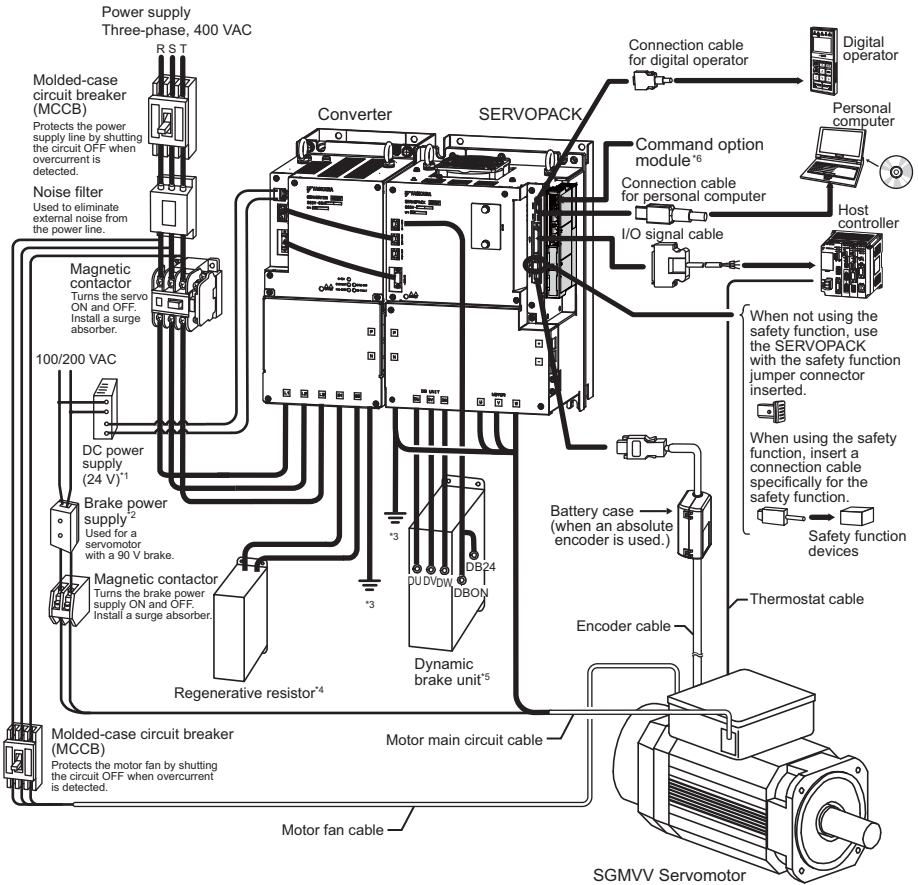

- *1. Use a 24-VDC power supply with double insulation or reinforced insulation (the power supply is not included).
- *2. Use a 24-VDC power supply (not included).
If using a 90-VDC power supply for a brake, however, use one of the following power supplies.
 - For 200-V input voltage: LPSE-2H01-E
 - For 100-V input voltage: LPDE-1H01-E
- *3. For details on grounding, refer to the user's manual for design and maintenance.
- *4. Before connecting an external regenerative resistor, refer to 3.5 *Selecting and Connecting a Regenerative Resistor Unit*.
- *5. For details on the dynamic brake unit, refer to 3.6 *Selecting and Connecting a Dynamic Brake Unit*.

3.3.4 SGD V-□□□□E1A SERVOPACK (Command Option Attachable Type)

- *6. For connection to the option module, refer to the user's manual of the corresponding option module.

3.4 Main Circuit Wiring

The names, specifications, and functions of the main circuit terminals required for trial operation are given below.

3.4.1 Names and Functions of Main Circuit Terminals

■ SERVOPACK

The following figure shows the appearance of the analog pulse-type SERVOPACK.

Note: For the purpose of this description, the SERVOPACK is shown with the front cover removed. Always keep the front cover attached when using the SERVOPACK. The main circuit terminals on the SERVOPACK are shared by all of the interfaces.

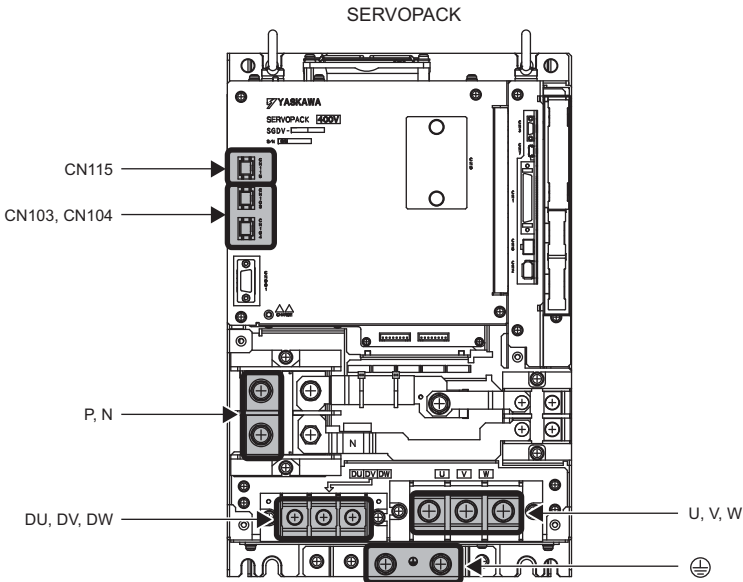

Terminals	Name	Specifications
P, N	Main circuit DC voltage input terminals	Connect these terminals to the P and N terminals on the converter.
U, V, W	Servomotor terminals	Connect these terminals to the Servomotor terminals.
CN103, CN104	Control power input connectors	CN103 is the 24 VDC ($\pm 15\%$) input. CN104 takes the same input, but it is normally not necessary to connect it.
DU, DV, DW	Dynamic brake unit terminals	Connect these terminals to the dynamic brake unit.
CN115	Dynamic brake unit connector	Connect this connector to the DBON and DB24 terminals on the dynamic brake unit.

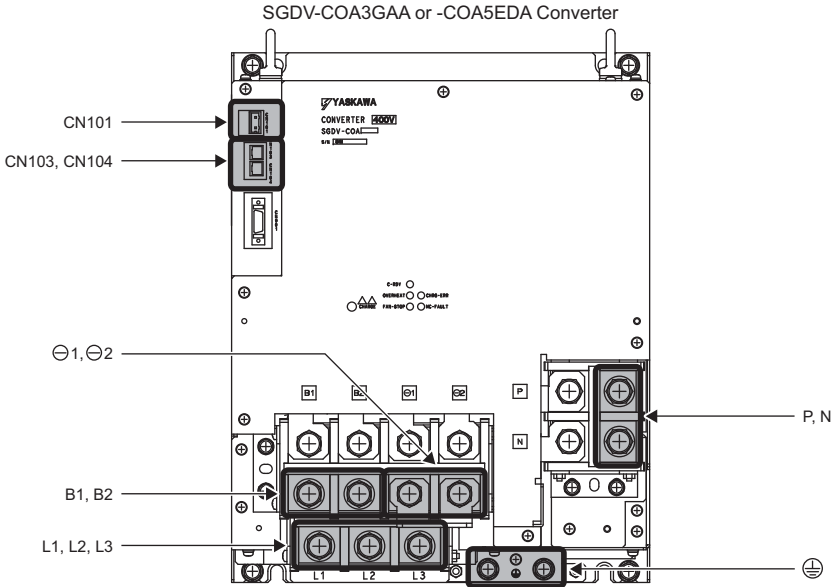

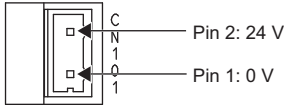
Terminals	Name	Specifications
L1, L2, L3	Main circuit power input terminals	SGDV-COA□□AA: Three-phase, 200 to 230 VAC, +10% to -15%, 50/60 Hz SGDV-COA□□DA: Three-phase, 380 to 480 VAC, +10% to -15%, 50/60 Hz
CN101	Control power input connector	SGDV-COA□□AA: Single-phase, 200 to 230 VAC, +10% to -15%, 50/60 Hz SGDV-COA□□DA: 24 VDC, ±15% Mating connector model: 231-202/026-000 (Manufactured by Wago Company of Japan, Ltd.) 
P, N	Main circuit DC voltage output terminals	Connect these terminals to the P and N terminals on the SERVOPACK.
⊕	Ground terminal	Connect this terminal to the power supply ground terminal and then ground it.
B1, B2	Regenerative resistor connection terminals	Connect these terminals to the regenerative resistor unit.
⊖1, ⊖2	DC reactor connection terminals	Remove the short bar before you connect a DC reactor.

(cont'd)

Terminals	Name	Specifications
CN103, CN104	Control power output connectors	CN103 and CN104 output 24 VDC to the SERVOPACK. For a 400-V system, the 24-VDC ($\pm 15\%$) input is output unaltered from CN103. CN104 provides the same output, but it is normally not necessary to connect it.

3.4.2 Connecting the Connectors

Connect CN901 and CN103 on the SERVOPACK and converter as shown in the following figure.

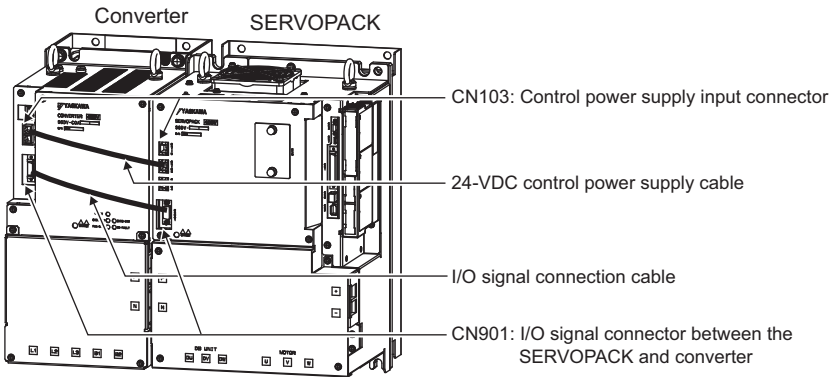

Cable Name	Cable Model	Cable Length	Description
IO signal connection cable	JZSP-CVI02-A4-E	0.4 m	This cable connects the CN901 connectors on the SERVOPACK and converter.
24-VDC control power supply cable	JZSP-CVG00-A4-E	0.4 m	This cable connects the CN103(CN104) connectors on the SERVOPACK and converter.

3.4.3 Interconnecting Terminals

Use the bus bars that are provided with the converter to connect the P and N terminals between the SERVOPACK and the converter.

The bus bars are different for different converter models.

(1) SGDV-COA2BAA or -COA3ZDA Converter

Attach the bus bars as shown in the following figure.

Note: The shapes of the ends of the bus bars are different for the SERVOPACK and converter connections and for the P terminal and N terminal connections.

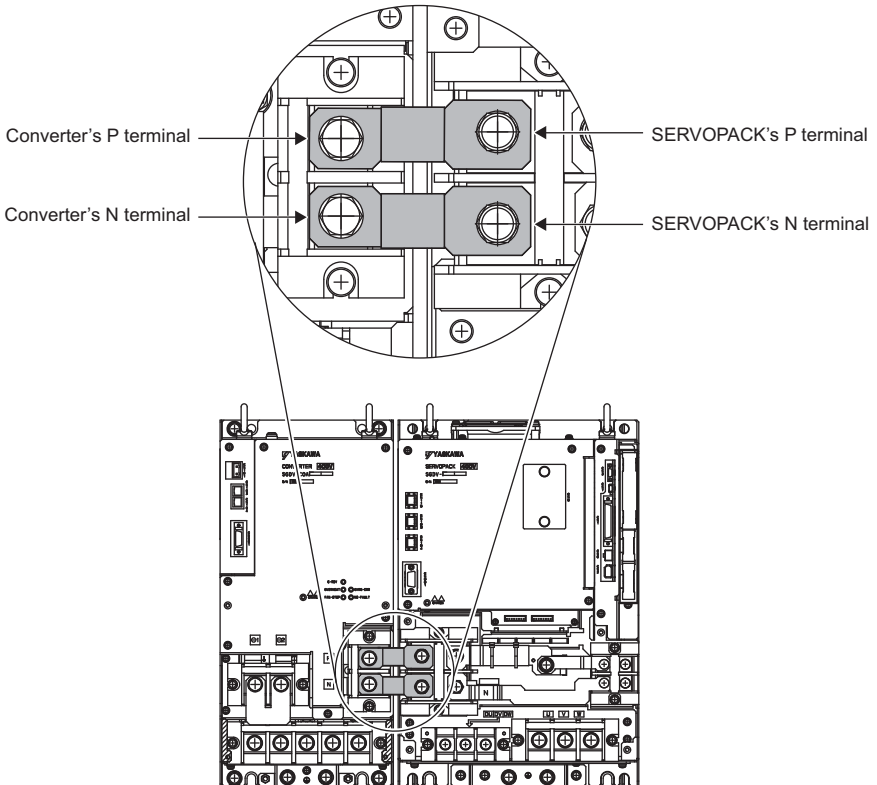

(2) SGDV-COA3GAA or -COA5EDA Converter

The bus bars can be connected in any direction.

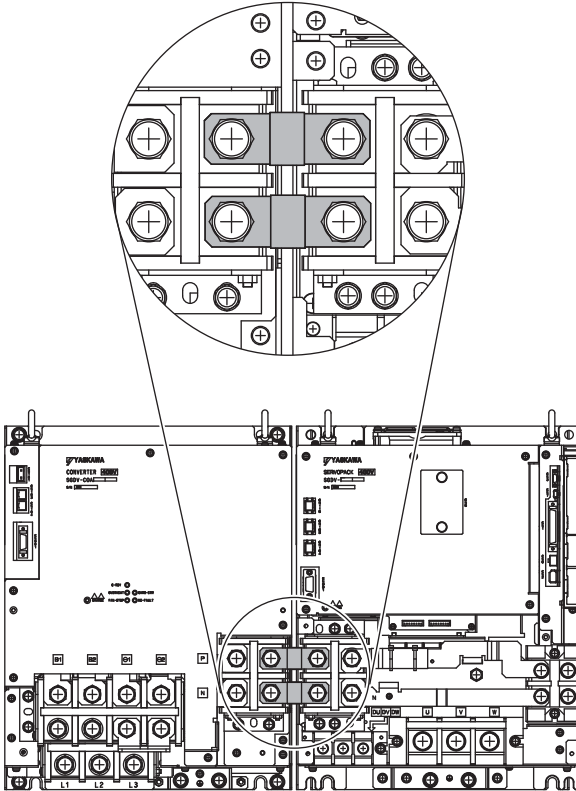

3.4.4 Main Circuit Wires

This section describes details about the main circuit wire for the SERVOPACK and the converter.



IMPORTANT

1. Wire sizes are selected for three cables per bundle at 40°C surrounding air temperature with the rated current.
2. Use a wire with a minimum withstand voltage of 600 V for the main circuit.
3. If cables are bundled in PVC or metal ducts, take into account the reduction of the allowable current.
4. Use a heat-resistant wire under high surrounding air or panel temperatures, where polyvinyl chloride insulated wires will rapidly deteriorate.

(1) Wire Types

Use the following type of wire for main circuit.

Cable Type		Allowable Conductor Temperature (°C)
Symbol	Name	
IV	600 V polyvinyl chloride insulated wire	60
HIV	600 V grade heat-resistant polyvinyl chloride insulated wire	75

The following table shows the wire sizes and allowable currents for three wires. Use wires with specifications equal to or less than those shown in the table.

Nominal Cross Section Diameter (mm ²)	AWG Size	Configuration (Number of Wires/mm)	Conductive Resistance (Ω/km)	Allowable Current at Surrounding Air Temperature (A)		
				30°C	40°C	50°C
0.5	(20)	19/0.18	39.5	6.6	5.6	4.5
0.75	(19)	30/0.18	26	8.8	7	5.5
0.9	(18)	37/0.18	24.4	9	7.7	6
1.25	(16)	50/0.18	15.6	12	11	8.5
2	(14)	7/0.6	9.53	23	20	16
3.5	(12)	7/0.8	5.41	33	29	24
5.5	(10)	7/1.0	3.47	43	38	31
8	(8)	7/1.2	2.41	55	49	40
14	(6)	7/1.6	1.35	79	70	57
22	(4)	7/2.0	0.85	91	81	66
38	(1)	7/2.6	0.49	124	110	93

(cont'd)



Nominal Cross Section Diameter (mm ²)	AWG Size	Configuration (Number of Wires/mm)	Conductive Resistance (Ω/km)	Allowable Current at Surrounding Air Temperature (A)		
				30°C	40°C	50°C
60	(2/0)	19/2.0	0.30	170	150	127
100	(4/0)	19/2.6	0.18	240	212	179

Note: These are reference values for 600-V-grade, heat-resistant, PVC-insulated wire.





(2) Wire Sizes

The following table shows the symbols for the power input terminals, screw sizes for terminals, tightening torque, wire sizes, and crimp terminals used for the SERVO-PACKs and converters.

■ For Three-phase, 200V

Combination of SERVOPACK and Converter ^{*1}		Terminal Symbols	Screw Size for Terminals	Tightening Torque (N·m)	HIV Wire Size in mm ² (AWG)	Crimp Terminal Model (Made by J.S.T. Mfg Co., Ltd.) ^{*2}
SGDV-121H	SERVO-PACK	P, N	M8	15.0	Bus bar attached to the converter	–
		U, V, W	M8	3.0	60 (2/0)	R60-8
		DU, DV, DW	M6	3.0	5.5 (10)	R5.5-6
			M8	9.0 to 1.0	60 (2/0)	R60-8
SGDV-COA2BAA	Converter	P, N	M8	3.0	Bus bar attached to the converter	–
		L1, L2, L3	M8	3.0	38 (1)	R38-8
		⊖1, ⊖2	M8	3.0	38 (1)	R38-8
		CN101 (L1C, L2C)	– (Connector)	–	1.25 (16)	–
		B1, B2	M8	3.0	8 (8)	R8-8
			M8	9.0 to 11.0	38 (1)	R38-8





(cont'd)

Combination of SERVOPACK and Converter*1		Terminal Symbols	Screw Size for Terminals	Tightening Torque (N·m)	HIV Wire Size in mm ² (AWG)	Crimp Terminal Model (Made by J.S.T. Mfg Co., Ltd.)*2
SGDV-161H	SERVO-PACK	P, N	M8	15.0	Bus bar attached to the converter	–
		U, V, W	M8	3.0	100 (4/0)	CB100-S8
		DU, DV, DW	M6	3.0	5.5 (10)	R5.5-6
			M8	9.0 to 11.0	100 (4/0)	100-8
SGDV-COA3GAA	Converter	P, N	M10	12 to 20	Bus bar attached to the converter	–
		L1, L2, L3	M10	12 to 20	60 (2/0)	R60-10
		⊖1, ⊖2	M10	12 to 20	60 (2/0)	R60-10
		CN101 (L1C, L2C)	– (Connector)	–	1.25 (16)	–
		B1, B2	M10	12 to 20	14 (6)	R14-10
			M8	9.0 to 11.0	60 (2/0)	R60-8
SGDV-201H	SERVO-PACK	P, N	M10	12 to 20	Bus bar attached to the converter	–
		U, V, W	M10	30.0	100 (4/0)	R100-10
		DU, DV, DW	M6	3.0	5.5 (10)	R5.5-6
			M8	9.0 to 11.0	100 (4/0)	100-8
SGDV-COA3GAA	Converter	P, N	M10	12 to 20	Bus bar attached to the converter	–
		L1, L2, L3	M10	12 to 20	100 (4/0)	R100-10
		⊖1, ⊖2	M10	12 to 20	100 (4/0)	R100-10
		CN101 (L1C, L2C)	– (Connector)	–	1.25 (16)	–
		B1, B2	M10	12 to 20	14 (6)	R14-10
			M8	9.0 to 11.0	100 (4/0)	100-8



*1. Use SERVOPACKs and converters in the specified combinations.

*2. Use the crimp terminals that are recommended by Yaskawa or an equivalent.

■ For Three-phase, 400V

Combination of SERVOPACK and Converter*1		Terminal Symbols	Screw Size for Terminals	Tightening Torque (N·m)	HIV Wire Size in mm ² (AWG)	Crimp Terminal Model (Made by J.S.T. Mfg Co., Ltd.)*2
SGDV-750J	SERVO-PACK	P, N	M8	15.0	Bus bar attached to the converter	—
		U, V, W	M8	3.0	22 (4)	R22-8
		DU, DV, DW	M6	3.0	3.5 (12)	3.5-6
			M8	9.0 to 11.0	22 (4)	R22-8
SGDV-COA3ZDA	Converter	P, N	M8	3.0	Bus bar attached to the converter	—
		L1, L2, L3	M8	3.0	22 (4)	R22-8
		⊖1, ⊖2	M8	3.0	22 (4)	R22-8
		CN101 (24 V, 0 V)	— (Connector)	—	1.25 (16)	—
		B1, B2	M8	3.0	8 (8)	R8-8
			M8	9.0 to 11.0	22 (4)	R22-8
SGDV-101J	SERVO-PACK	P, N	M8	15.0	Bus bar attached to the converter	—
		U, V, W	M8	3.0	38 (1)	R38-8
		DU, DV, DW	M6	3.0	3.5 (12)	3.5-6
			M8	9.0 to 11.0	38 (1)	R38-8
SGDV-COA5EDA	Converter	P, N	M10	12 to 20	Bus bar attached to the converter	—
		L1, L2, L3	M10	12 to 20	38 (1)	R38-10
		⊖1, ⊖2	M10	12 to 20	38 (1)	R38-10
		CN101 (24 V, 0 V)	— (Connector)	—	1.25 (16)	—
		B1, B2	M10	12 to 20	8 (8)	R8-10
			M8	9.0 to 11.0	38 (1)	R38-8

(cont'd)

Combination of SERVOPACK and Converter*1		Terminal Symbols	Screw Size for Terminals	Tightening Torque (N·m)	HIV Wire Size in mm ² (AWG)	Crimp Terminal Model (Made by J.S.T. Mfg Co., Ltd.)*2
SGDV-131J SGDV-COASEDA	SERVO-PACK	P, N	M10	12 to 20	Bus bar attached to the converter	–
		U, V, W	M10	30.0	60 (2/0)	R60-10
		DU, DV, DW	M6	3.0	3.5 (12)	3.5-6
			M8	9.0 to 11.0	60 (2/0)	R60-8
	Converter	P, CN	M10	12 to 20	Bus bar attached to the converter	–
		L1, L2, L3	M10	12 to 20	60 (2/0)	R60-10
		⊖1, ⊖2	M10	12 to 20	60 (2/0)	R60-10
		CN101 (24 V, 0 V)	– (Connector)	–	1.25 (16)	–
		B1, B2	M10	12 to 20	14 (6)	R14-10
			M8	9.0 to 11.0	60 (2/0)	R60-8

*1. Use SERVOPACKs and converters in the specified combinations.

*2. Use the crimp terminals that are recommended by Yaskawa or an equivalent.

■ Tools for Crimp Terminals





Model	Tools (by J.S.T. Mfg Co., Ltd.)		
	Body	Head	Dies
3.5-6	YHT-2210	-	-
R5.5-6			
R8-8	YHT-8S	-	-
R8-10	YPT-150-1	-	TD-221, TD-211
R14-10	Body only: YPT-150-1 or Body: YF-1; Head: YET-150-1		TD-222, TD-211
R22-8			TD-223, TD-212
R38-8 R38-10			TD-224, TD-212
R60-8 R60-10			TD-225, TD-213
100-8 R100-10 CB100-S8			TD-228, TD-214

(3) Wire Size (UL Standard)



To comply with the UL standard, use the recommended wires.

The following table shows the wire sizes (AWG) at a rating of 75 °C.

■ For Three-phase, 200V





Combination of SERVOPACK and Converter*		Terminal Symbols	Screw Size for Terminals	Tightening Torque (N·m)	Wire Size AWG
SGDV-121H SGDV- COA2BAA	SERVOPACK	P, N	M8	15.0	Bus bar attached to the converter
		U, V, W	M8	3.0	1/0
		DU, DV, DW	M6	3.0	10
			M8	9.0 to 11.0	1/0
	Converter	P, N	M8	3.0	Bus bar attached to the converter
		L1, L2, L3	M8	3.0	1/0
		⊖1, ⊖2	M8	3.0	1/0
		CN101 (L1C, L2C)	– (Connector)	–	14
		B1, B2	M8	3.0	6
			M8	9.0 to 11.0	1/0
SGDV-161H SGDV- COA3GAA	SERVOPACK	P, N	M8	15.0	Bus bar attached to the converter
		U, V, W	M8	3.0	3/0
		DU, DV, DW	M6	3.0	10
			M8	9.0 to 11.0	3/0
	Converter	P, N	M10	12 to 20	Bus bar attached to the converter
		L1, L2, L3	M10	12 to 20	3/0
		⊖1, ⊖2	M10	12 to 20	3/0
		CN101 (L1C, L2C)	– (Connector)	–	14
		B1, B2	M10	12 to 20	4
			M8	9.0 to 11.0	3/0

(cont'd)



Combination of SERVOPACK and Converter*		Terminal Symbols	Screw Size for Terminals	Tightening Torque (N·m)	Wire Size AWG
SGDV-201H SGDV-COA3GAA	SERVOPACK	P, N	M10	12 to 20	Bus bar attached to the converter
		U, V, W	M10	30.0	250
		DU, DV, DW	M6	3.0	10
			M8	9.0 to 11.0	250
	Converter	P, N	M10	12 to 20	Bus bar attached to the converter
		L1, L2, L3	M10	12 to 20	4/0
		⊖1, ⊖2	M10	12 to 20	4/0
		CN101 (L1C, L2C)	– (Connector)	–	14
		B1, B2	M10	12 to 20	4
			M8	9.0 to 11.0	4/0

* Use SERVOPACKs and converters in the specified combinations.

■ For Three-phase, 400V

Combination of SERVOPACK and Converter*		Terminal Symbols	Screw Size for Terminals	Tightening Torque (N·m)	Wire Size AWG
SGDV-750J SGDV-COA3ZDA	SERVOPACK	P, N	M8	15.0	Bus bar attached to the converter
		U, V, W	M8	3.0	3
		DU, DV, DW	M6	3.0	10
			M8	9.0 to 11.0	3
	Converter	P, N	M8	3.0	Bus bar attached to the converter
		L1, L2, L3	M8	3.0	3
		⊖1, ⊖2	M8	3.0	3
		CN101 (24 V, 0 V)	– (Connector)	–	14
		B1, B2	M8	3.0	8
			M8	9.0 to 11.0	3
SGDV-101J SGDV-COA5EDA	SERVOPACK	P, N	M8	15.0	Bus bar attached to the converter
		U, V, W	M8	3.0	1
		DU, DV, DW	M6	3.0	10
			M8	9.0 to 11.0	1
	Converter	P, N	M10	12 to 20	Bus bar attached to the converter
		L1, L2, L3	M10	12 to 20	2
		⊖1, ⊖2	M10	12 to 20	2
		CN101 (24 V, 0 V)	– (Connector)	–	14
		B1, B2	M10	12 to 20	8
			M8	9.0 to 11.0	2







(cont'd)

Combination of SERVOPACK and Converter*		Terminal Symbols	Screw Size for Terminals	Tightening Torque (N·m)	Wire Size AWG
SGDV-131J SGDV-COA5EDA	SERVOPACK	P, N	M10	12 to 20	Bus bar attached to the converter
		U, V, W	M10	30.0	2/0
		DU, DV, DW	M6	3.0	10
			M8	9.0 to 11.0	2/0
	Converter	P, N	M10	12 to 20	Bus bar attached to the converter
		L1, L2, L3	M10	12 to 20	2/0
		⊖1, ⊖2	M10	12 to 20	2/0
		CN101 (24 V, 0 V)	– (Connector)	–	14
		B1, B2	M10	12 to 20	4
			M8	9.0 to 11.0	2/0

* Use SERVOPACKs and converters in the specified combinations.

■ Crimp Terminal, Sleeve, Terminal Kit







- For Three-phase, 200 V

Combination of SERVOPACK and Converter		Terminal Symbols	Crimp Terminal Model (Made by J.S.T. Mfg Co., Ltd.) ^{*1}	Sleeve Model (Made by Tokyo Dip Co., Ltd.) ^{*2}	Terminal Kit Model ^{*3}
SGDV-121H	SERVO- PACK	U, V, W	R60-8	TP-060 (black)	JZSP-CVT9-121H-E
		DU, DV, DW	R5.5-6	TP-006 (black)	
			R60-8	–	
SGDV- COA2BAA	Converter	L1, L2, L3	R60-8	TP-060 (black)	JZSP-CVT9-2BA-E
		⊖1, ⊖2	R60-8	TP-060 (white)	
		B1, B2	R14-8	TP-022 (white)	
			R60-8	–	
SGDV-161H	SERVO- PACK	U, V, W	CB80-S8	TP-100 (black)	JZSP-CVT9-161H-E
		DU, DV, DW	R5.5-6	TP-006 (black)	
			80-8	–	
SGDV- COA3GAA	Converter	L1, L2, L3	80-10	TP-100 (black)	JZSP-CVT9-3GA1-E
		⊖1, ⊖2	80-10	TP-100 (white)	
		B1, B2	R22-10	TP-038 (white)	
			80-8	–	
SGDV-201H	SERVO- PACK	U, V, W	CB150-S10	TP-150 (black)	JZSP-CVT9-201H-E
		DU, DV, DW	R5.5-6	TP-006 (black)	
			150-8	–	
SGDV- COA3GAA	Converter	L1, L2, L3	R100-10	TP-125 (black)	JZSP-CVT9-3GA2-E
		⊖1, ⊖2	R100-10	TP-125 (white)	
		B1, B2	R22-10	TP-038 (white)	
			100-8	–	

- *1. Use SERVOPACKS and converters in the specified combinations.
- *2. Use sleeves for the crimped section of the terminals.
- *3. A terminal kit includes the crimp terminals and sleeves required for one SERVOPACK or converter.

3.4.4 Main Circuit Wires

- For Three-phase, 400 V

Combination of SERVOPACK and Converter		Terminal Symbols	Crimp Terminal Model (Made by J.S.T. Mfg Co., Ltd.)* ¹	Sleeve Model (Made by Tokyo Dip Co., Ltd.)* ²	Terminal Kit Model* ³
SGDV-750J	SERVO-PACK	U, V, W	R38-8	TP-038 (black)	JZSP-CVT9-750J-E
		DU, DV, DW	R5.5-6	TP-006 (black)	
			R38-8	–	
SGDV-COA3ZDA	Converter	L1, L2, L3	R38-8	TP-038 (black)	JZSP-CVT9-3ZD-E
		⊖1, ⊖2	R38-8	TP-038 (white)	
		B1, B2	R8-8	TP-014 (white)	
			R38-8	–	
SGDV-101J	SERVO-PACK	U, V, W	R60-8	TP-060 (black)	JZSP-CVT9-101J-E
		DU, DV, DW	R5.5-6	TP-006 (black)	
			R60-8	–	
SGDV-COA5EDA	Converter	L1, L2, L3	R38-10	TP-038 (black)	JZSP-CVT9-5ED1-E
		⊖1, ⊖2	R38-10	TP-038 (white)	
		B1, B2	R8-10	TP-014 (white)	
			R38-8	–	
SGDV-131J	SERVO-PACK	U, V, W	70-10	TP-080 (black)	JZSP-CVT9-131J-E
		DU, DV, DW	R5.5-6	TP-006 (black)	
			70-8	–	
SGDV-COA5EDA	Converter	L1, L2, L3	70-10	TP-080 (black)	JZSP-CVT9-5ED2-E
		⊖1, ⊖2	70-10	TP-080 (white)	
		B1, B2	R22-10	TP-038 (white)	
			70-8	–	

*1. Use SERVOPACKs and converters in the specified combinations.

*2. Use sleeves for the crimped section of the terminals.

*3. A terminal kit includes the crimp terminals and sleeves required for one SERVOPACK or converter.

■ Tools for Crimp Terminals

Model	Tools by J.S.T. Mfg Co., Ltd.		
	Body	Head	Dies
R5.5-6	YHT-2210	–	–
R8-8	YHT-8S	–	–
	YPT-150-1	–	TD-221, TD-211
R14-8	Body only: YPT-150-1 or Body: YF-1; Head: YET-150-1		TD-222, TD-211
R22-10			TD-223, TD-212
R38-8 R38-10			TD-224, TD-212
R60-8			TD-225, TD-213
70-8 70-10			TD-226, TD-213
80-8 80-10 CB80-S8			TD-227, TD-214
100-8 R100-10			TD-228, TD-214
150-8 CB150-S10			TD-229, TD-215

3.4.5 Typical Main Circuit Wiring Examples

CAUTION

- Be sure to observe the following precautions when wiring the main circuit's terminals and connectors on a SERVOPACK or converter.
 - Do not turn ON the power to a SERVOPACK or converter until all wiring, including the wiring to the main circuit terminal connectors, has been completed.
 - Remove main circuit connectors from the SERVOPACK and the converter before wiring.
 - Insert only one power line per opening in the main circuit terminals.
 - Make sure that no part of the core wire comes into contact with (i.e., short-circuits) adjacent wires.

IMPORTANT

- Use a molded-case circuit breaker (1QF) or fuse to protect the main circuit.

The SERVOPACK and the converter connects directly to a commercial power supply; it is not isolated through a transformer or other device.

Always use a molded-case circuit breaker (1QF) or fuse to protect the servo system from accidents involving different power system voltages or other accidents.
- Install a ground fault detector.

The SERVOPACK and the converter does not have a built-in protective circuit for grounding.

To configure a safer system, install a ground fault detector against overloads and short-circuiting, or install a ground fault detector combined with a molded-case circuit breaker.
- Do not frequently turn power ON and OFF.
 - Frequently turning power ON and OFF causes elements inside the SERVOPACK and the converter to deteriorate. Do not use the servo drive with an application that requires frequently turning power ON and OFF.
 - After the actual operation starts, the allowable interval for turning power ON and OFF is one hour or longer.

The following diagrams show wiring examples of the SERVOPACK and converter.

(1) Single-axis Application

■ Three-phase 200 V

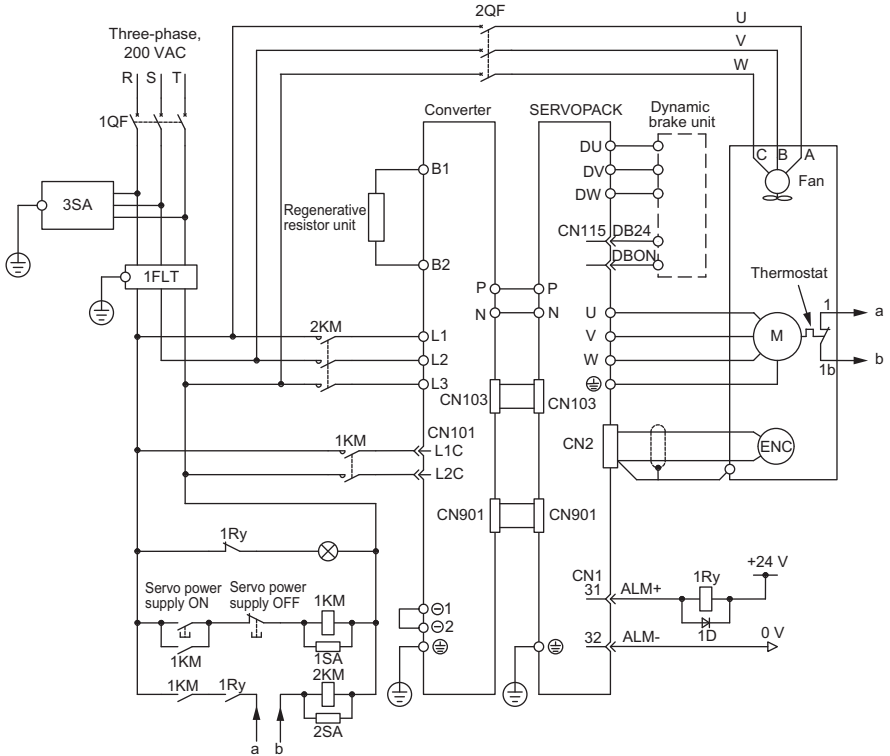

- 1QF: Molded-case circuit breaker
- 2QF: Molded-case circuit breaker
- 1FIL: Noise filter
- 1KM: Magnetic contactor (for control power supply)
- 2KM: Magnetic contactor (for main power supply)
- 1Ry: Relay

- 1PL: Indicator lamp
- 1SA: Surge absorber
- 2SA: Surge absorber
- 3SA: Surge absorber
- 1D: Flywheel diode

(2) Multi-axis Application

Connect the alarm output (ALM) terminals for the three SERVOPACKs in series to enable alarm detection relay 1RY to operate.

When the alarm occurs, the ALM output signal transistor is turned OFF.

The following diagram shows a wiring example for three-phase, 400-VAC SERVO-PACK with converter.

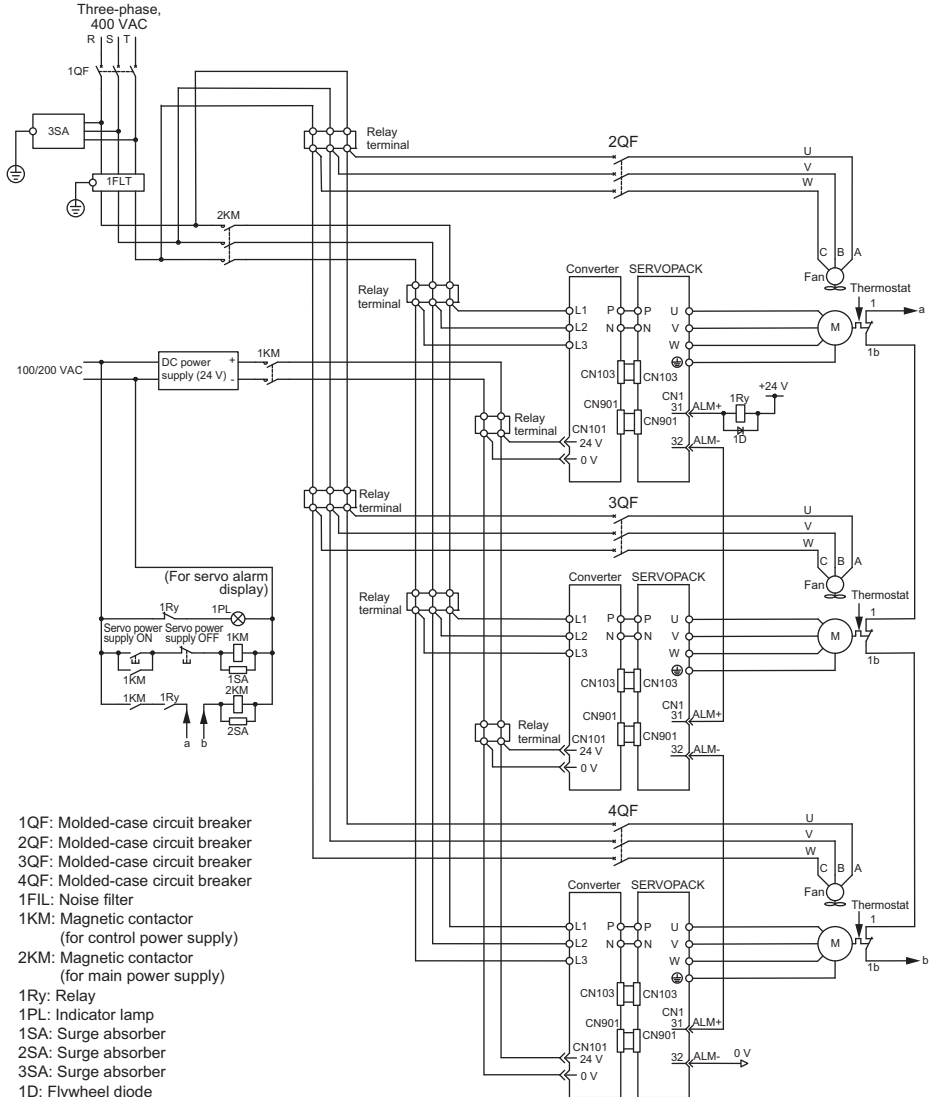

- 1QF: Molded-case circuit breaker
- 2QF: Molded-case circuit breaker
- 3QF: Molded-case circuit breaker
- 4QF: Molded-case circuit breaker
- 1FLT: Noise filter
- 1KM: Magnetic contactor (for control power supply)
- 2KM: Magnetic contactor (for main power supply)
- 1Ry: Relay
- 1PL: Indicator lamp
- 1SA: Surge absorber
- 2SA: Surge absorber
- 3SA: Surge absorber
- 1D: Flywheel diode

3.5 Selecting and Connecting a Regenerative Resistor Unit

The SERVOPACKs and converters do not contain a regenerative resistor. Select and connect a regenerative resistor unit and set the regenerative resistor capacity in Pn600 as described in this section.

Contact your Yaskawa representative or the sales department for the detailed specifications of the regenerative resistor units.

WARNING

- Be sure to connect the regenerative resistor unit correctly. Do not short-circuit between B1 and B2. Doing so may result in fire or damage to the regenerative resistor unit, SERVOPACK, or converter or other devices.

3.5.1 Selecting a Regenerative Resistor Unit

The regenerative resistor units specified by Yaskawa are listed in the following table. You must acquire the regenerative resistor units separately. Use it only in one of the combinations that are given in the following table.

SERVOPACK Model SGD V-	Converter Model SGD V-COA	Model of Applicable Regenerative Resistor Unit	Resistance (Ω)	Specifications
121H	2BAA	JUSP-RA08-E	2.4	Four 0.6- Ω (600-W) resistors connected in series.
161H	3GAA	JUSP-RA09-E	1.8	Two sets of four 0.9- Ω (600-W) resistors connected in series are connected in parallel.
201H		JUSP-RA11-E	1.6	Eight 0.2- Ω (600-W) resistors connected in series.
750J	3ZDA	JUSP-RA13-E	6.7	Three sets of two 10- Ω (600-W) resistors connected in series are connected in parallel.
101J	5EDA	JUSP-RA14-E	5	Four sets of two 10- Ω (600-W) resistors connected in series are connected in parallel.
131J		JUSP-RA16-E	3.8	Four sets of three 5- Ω (600-W) resistors connected in series are connected in parallel.

3.5.2 Connecting a Regenerative Resistor Unit

Connect the B1 terminals and connect the B2 terminals between the converter and regenerative resistor unit. Connect them as shown in the following figures.

(1) Converter Model: SGDV-COA2BAA or -COA3ZDA

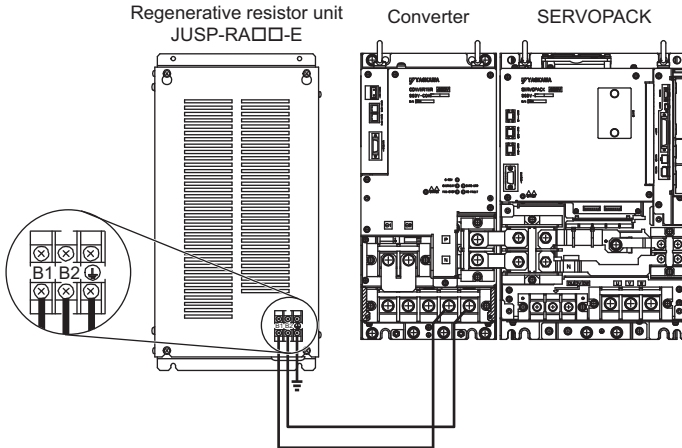

(2) Converter Model: SGDV-COA3GAA or -COA5EDA

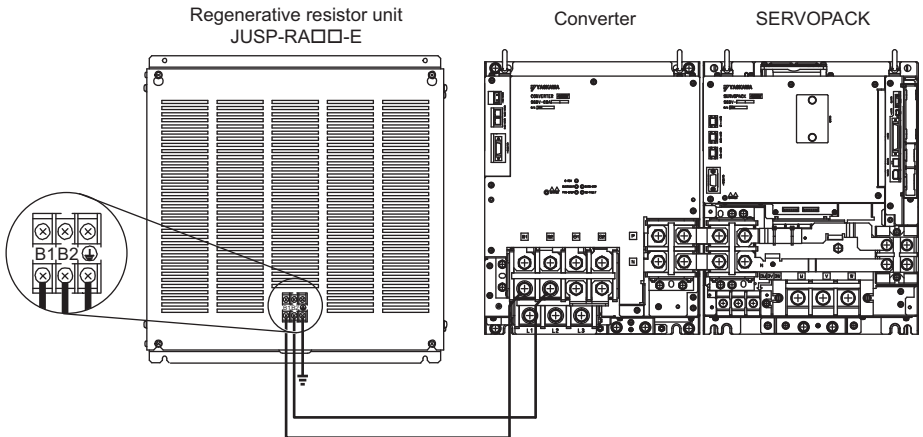

3.5.3 Setting Regenerative Resistor Capacity

Set the regenerative resistor capacity (Pn600) as follows:

Using the regenerative resistor that is specified by Yaskawa: Use the default setting.

Using any other regenerative resistor: Refer to the user's manual for design and maintenance.

3.5.4 Installation Standards

Observe the following installation standards when you use a regenerative resistor unit specified by Yaskawa. Provide at least 70 mm on each side of the unit and at least 200 mm at both the top and bottom of the unit to enable fan and natural convection cooling.

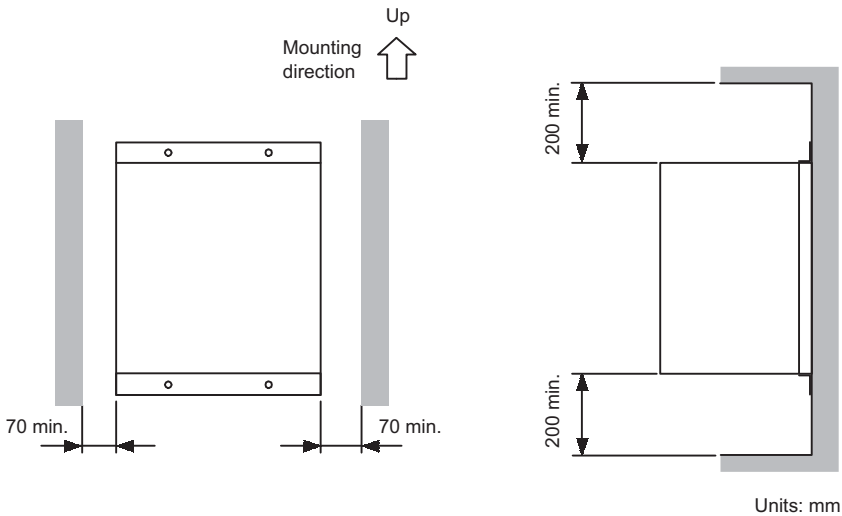

If you use a non-specified regenerative resistor unit, follow the specifications of the regenerative resistor unit when you install it.

3.6 Selecting and Connecting a Dynamic Brake Unit

To use the dynamic brake (DB), externally connect a dynamic brake unit or dynamic brake resistor to the SERVOPACK to process the dynamic braking energy. Set Pn001 to n.□□□2 if you do not use the dynamic brake. In this case, it is not necessary to connect a dynamic brake unit.

3.6.1 Selection

Use the following tables to select a dynamic brake unit or dynamic brake resistor.

SERVOPACK Model: SGDv-	Dynamic Brake Unit Model	Resistance Specifications (Star Wiring Δ)	Dynamic Brake Contactor and Surge Absorption Unit
121H, 161H, 201H	JUSP-DB02-E	180 W, 0.3 Ω	Built into dynamic brake unit.
750J, 101J	JUSP-DB04-E	180 W, 0.8 Ω	
131J	JUSP-DB06-E	300 W, 0.8 Ω	

3.6.2 Connections

(1) Using a Dynamic Brake Unit from Yaskawa

When connecting a dynamic brake, refer to the following diagram.

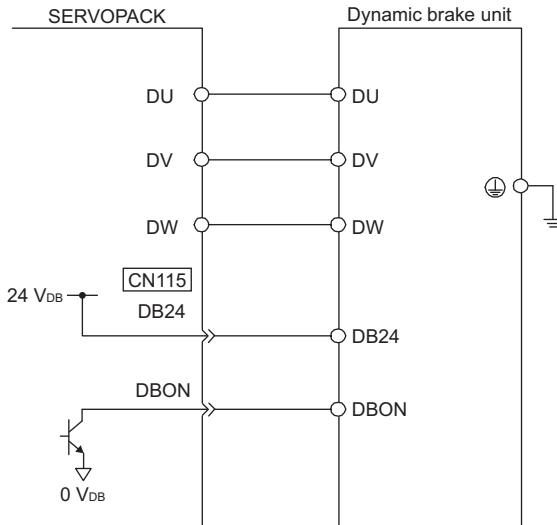

Note: The dynamic brake answer function cannot be used, because the contactor has no auxiliary contacts.

(2) Using a Dynamic Brake Unit from Another Company

- Using NO Contacts for the Dynamic Brake Contactor

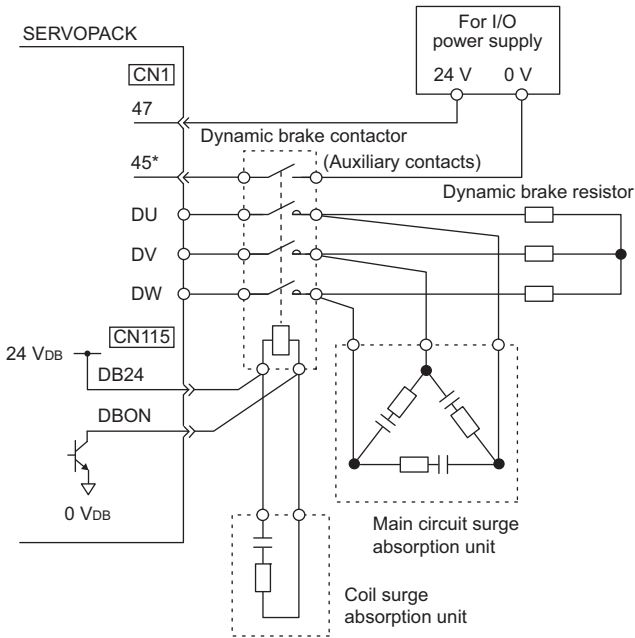

* The above figure is for using a dynamic brake contactor with NO contacts. The dynamic brake answer signal (a signal from NO auxiliary contacts) is input to CN1-45. To indicate an error if the input signal to CN1-45 turns OFF (open) while the dynamic brake is activated, the Pn515 parameter in the SERVOPACK must be set to n.□E□□. If the dynamic brake answer signal is not used, Pn515 is set to n.□8□□ (default setting).

- Note: 1. If you assign more than one signal to the same input circuit, OR logic will be used and any of the input signals will cause the circuit to operate. This may result in unexpected operation.
2. The maximum current for DB24 and DBON is 300 mA.

• Using NC Contacts for the Dynamic Brake Contactor

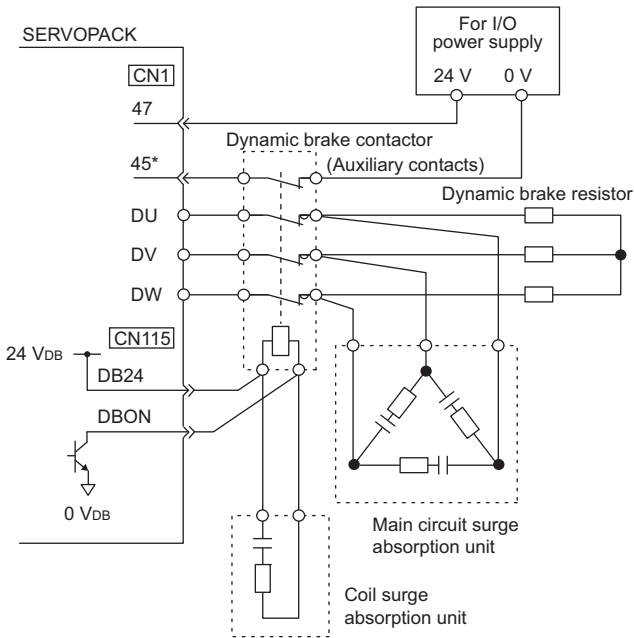

- * The above figure is for using a dynamic brake contactor with NC contacts. The dynamic brake answer signal (a signal from NC auxiliary contacts) is input to CN1-45. To indicate an error if the input signal to CN1-45 turns OFF (open) while the dynamic brake is activated, the Pn515 parameter in the SERVOPACK must be set to n.□E□□. If the dynamic brake answer signal is not used, Pn515 is set to n.□8□□ (default setting).
- Note: 1. If you assign more than one signal to the same input circuit, OR logic will be used and any of the input signals will cause the circuit to operate. This may result in unexpected operation.
2. The maximum current for DB24 and DBON is 300 mA.

3.6.3 Installation Standards

- If the coil current of NC dynamic brake contactors is 300 mA or higher, obtain an NO relay that can switch the contactor coil current and voltage and a power supply for the contactor coil.

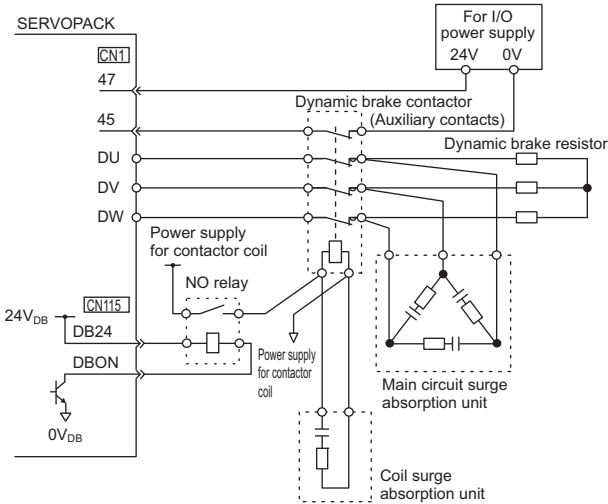

3.6.3 Installation Standards

Observe the following installation standards when you use a Yaskawa dynamic brake unit. Provide at least 70 mm on each side of the unit and at least 200 mm at both the top and bottom of the unit to enable fan and natural convection cooling.

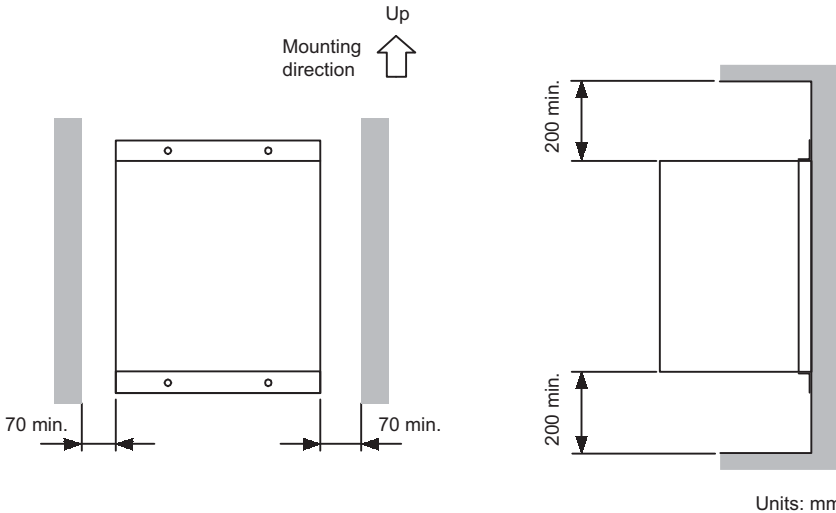

Safety Function

This chapter describes the safety functions.

4.1 Outline	4-2
4.2 Hard Wire Base Block (HWBB) Function	4-3
4.3 Safety Function Signal (CN8) Names and Functions	4-4
4.4 Precautions When Not Using the Safety Function	4-5
4.5 Connecting a Safety Function Device	4-5

4.1 Outline

The safety function is incorporated in the SERVOPACK and the converter to reduce the risk associated with the machine by protecting workers from injury and by securing safe machine operation. Especially when working in hazardous areas inside the safeguard, as for machine maintenance, it can be used to avoid adverse machine movement.

The person who designs a system using the safety function (Hard Wire Baseblock function) must have full knowledge of the related safety standards and full understanding of the user's manual for your SERVOPACK.

4.2 Hard Wire Base Block (HWBB) Function

The Hard Wire Base Block function (hereinafter referred to as HWBB function) is a safety function designed to baseblock the motor (shut off the motor current) by using the hardwired circuits: Each circuit for two channel input signals blocks the run signal to turn OFF the power module, and the motor current is shut off. (Refer to the diagram below.)

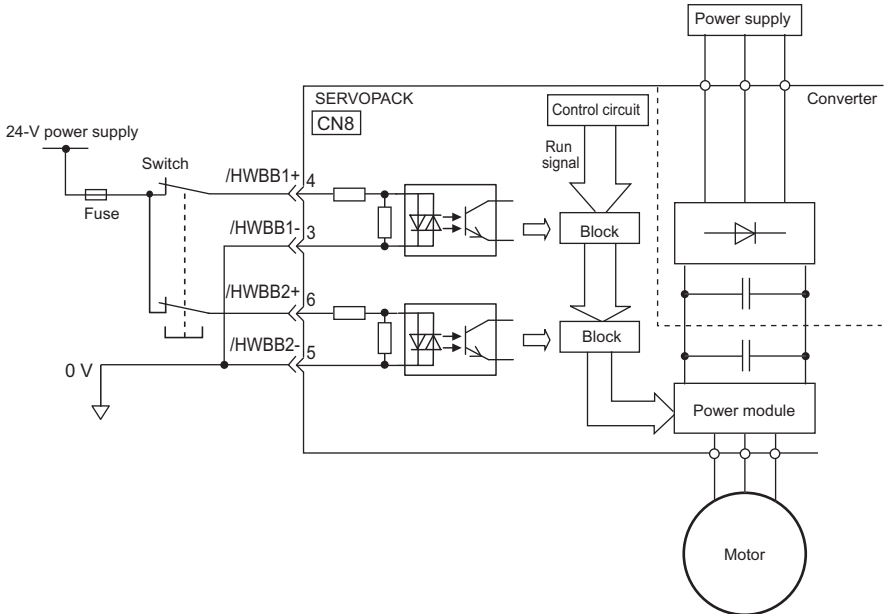

Note: For safety function signal connections, the input signal is the 0 V common and the output signal is the source output. This is opposite to other signals described in this manual.

To avoid confusion, the ON and OFF status of signals for safety functions are defined as follows:

ON: The state in which the relay contacts are closed or the transistor is ON and current flows into the signal line.

OFF: The state in which the relay contacts are open or the transistor is OFF and no current flows into the signal line.

 WARNING
<ul style="list-style-type: none"> When using the HWBB function, be sure to perform a risk assessment of the servo system in advance. Make sure that the safety level of the standards is met. For details about the standards, refer to Harmonized Standards at the front of this manual. To meet the performance level d (PLd) in EN ISO 13849-1, the EDM signal must be monitored by a host controller. If the EDM signal is not monitored by a host controller, the system only qualifies for the performance level c (PLc). The following risks can be estimated even if the HWBB function is used. These risks must be included in the risk assessment. The servomotor will move in an application where external force is applied to the servomotor (for example, gravity on the vertical axis). Take measures to secure the servomotor, such as installing a mechanical brake. The servomotor may move within the electric angle of 180 degrees in case of the power module failure, etc. Make sure that safety is ensured even in that situation. The maximum motor rotation angle is 1/6 of a rotation (This is the converted rotation angle for the motor shaft). The HWBB function does not shut off the power to the SERVOPACK or electrically isolate it. Take measures to shut off the power to the SERVOPACK when performing maintenance on it.

4.3 Safety Function Signal (CN8) Names and Functions

The following table shows the terminal layout of safety function signals (CN8).

Pin No.	Signal Name	Function	
1*	-	-	-
2*	-	-	-
3	/HWBB1-	Hard wire baseblock input 1	Hard wire baseblock input Baseblock (motor current off) when OFF
4	/HWBB1+		
5	/HWBB2-	Hard wire baseblock input 2	
6	/HWBB2+		
7	EDM1-	Monitored circuit status output 1	ON when the /HWBB1 and the /HWBB2 signals are input and the SERVOPACK enters a baseblock state.
8	EDM1+		

* Do not use unused terminals. (connected to the internal circuits)

4.4 Precautions When Not Using the Safety Function

When not using the safety function or when performing a JOG operation, use the SERVOPACK and the converter with the safety function jumper connector (provided as an accessory) inserted. If the SERVOPACK and the converter is used without the jumper connector inserted into CN8, no current will flow to the motor and no torque will be output.

When Hbb is displayed on the panel operator and digital operator, the motor is base-blocked by the safety function. Check to see if the jumper connector is correctly inserted into CN8.

4.5 Connecting a Safety Function Device

Connect a safety function device using the following procedure.

1. Remove the safety function's jumper connector from CN8.

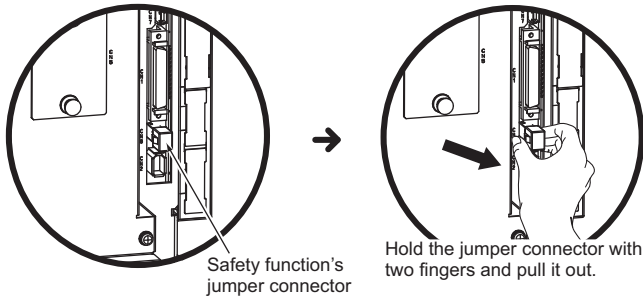

2. Connect a safety function device to CN8.

Note: When not using the safety function, use the SERVOPACK with the safety function's jumper connector (JZSP-CVH05-E provided as an accessory) inserted in CN8. If the SERVOPACK is used without the jumper connector inserted into CN8, no current will flow to the servomotor and no torque will be output. In this case, "Hbb" will be displayed on the panel operator or the digital operator.

Trial Operation (Checking Servomotor Operation)

This chapter describes how to perform trial operation.

5.1 Outline	5-2
5.2 Inspection and Checking before Trial Operation	5-3
5.3 JOG Operation Using a Panel Operator	5-6
5.4 JOG Operation Using a Digital Operator	5-8
5.5 JOG Operation Using SigmaWin+	5-11

5.1 Outline

The trial operation described here is a JOG operation for servomotors not connected to machinery (without a load). The purpose of this trial operation is to check whether the SERVOPACK and the converter and servomotor are properly connected and whether the servomotor is operating normally.

To conduct trial operation executed from the host controller for the servomotor without load, or for the servomotor connected to the machine, refer to the user's manual for your SERVOPACK.

CAUTION

- Conduct trial operation on the servomotor alone with the motor shaft disconnected from the machine to avoid any unexpected accidents. If it is unavoidable to perform trial operation while connected to a machine, then always make sure that an emergency stop can be immediately executed.

5.2 Inspection and Checking before Trial Operation

To ensure safe and correct trial operation, inspect and check the following items before starting trial operation.

■ Servomotors

Inspect and check the following items, and take appropriate measures before performing trial operation if any problem exists.

- Are all wiring and connections correct?
- Are all nuts and bolts securely tightened?
- If the servomotor has an oil seal, is the seal undamaged and is the motor oiled?
- If the servomotor has a brake, is the brake released beforehand? To release the brake, apply the specified voltage (24 VDC or 90 VDC). The following diagram shows an example of the circuit wiring needed to release the holding brake before a trial operation.

An example of the circuit wiring

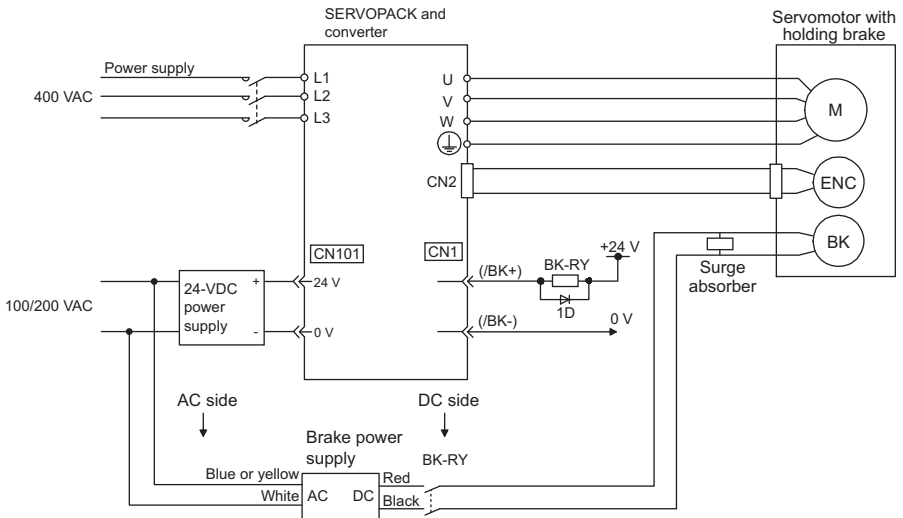

BK-RY: Brake control relay

Brake power supply for 90 V Input voltage 200-V models: LPSE-2H01-E
Input voltage 100-V models: LPDE-1H01-E

A 24-VDC power supply for a 24-VDC brake is not included.

■ SERVOPACKs and Converters

Inspect and check the following items, and take appropriate measures before performing trial operation if any problem exists.

- Are all installation, wiring and connections correct?
- Is the correct power supply voltage being supplied to the SERVOPACK and the converter?

■ Installing the Servomotor, SERVOPACK, and Converter

Install the servomotor, the SERVOPACK, and the converter according to the installation conditions.

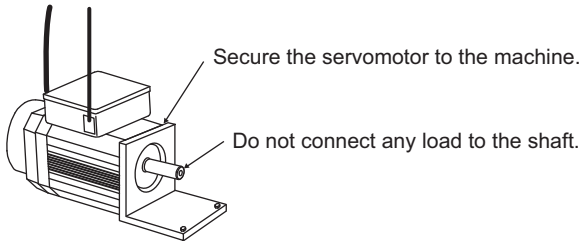

<Note>

- Be sure to secure the servomotor to the equipment, or the servomotor may turn over when it starts rotating.
- Do not connect anything to the servomotor shaft.

■ Checking the Main Circuit Power Supply, Servomotor, and Encoder Wiring

Once again, check the main circuit power supply, servomotor, and encoder wiring that was described in *Chapter 3 Wiring and Connection*.

Perform a trial operation with the safety function jumper connector (provided as an accessory) inserted into the CN8 connector.

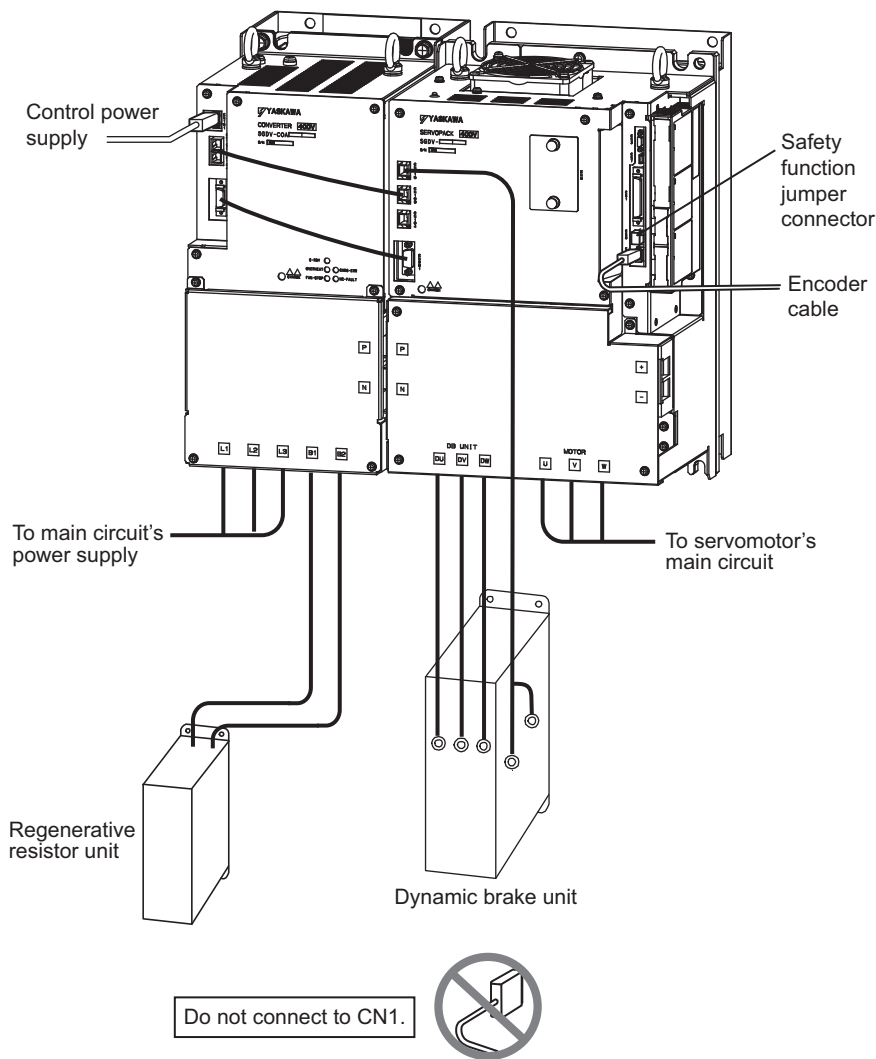

5.3 JOG Operation Using a Panel Operator

This section describes the procedure for executing a JOG operation using a panel operator.

The operating section of the panel operator is behind the plastic plate at the top of the front of the SERVOPACK. Pull the plungers and remove the plastic cover to operate the panel operator (The panel operator is provided only on SERVOPACKs for analog pulses).

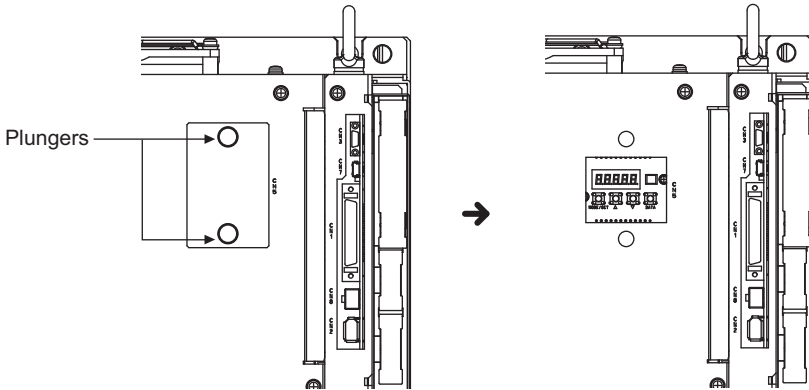

Step	Display after operation	Keys	Operation
1		-	Turn ON the power to the SERVOPACK and the converter. The forward run prohibited (P-OT) or reverse run prohibited (N-OT) message is displayed. When the JOG operation is executed, P-OT and N-OT are automatically disabled.
2			Press the MODE/SET Key to select the utility function.
3			Press the UP or DOWN Key to select Fn002.
4			Press the DATA/SHIFT Key for approximately one second. The display shown on the left appears.
5			Press the MODE/SET Key to turn the servomotor power ON.

(cont'd)

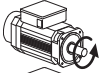
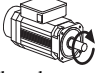
Step	Display after operation	Keys	Operation
6			<p>The servomotor will rotate at the speed set in Pn304 while the UP Key (for forward rotation) or DOWN Key (for reverse rotation) is pressed (The factory setting is 500 min⁻¹).</p> <div style="display: flex; justify-content: space-around; align-items: center;"> <div style="text-align: center;">  <p>Forward</p> </div> <div style="text-align: center;">  <p>Reverse</p> </div> </div> <p>Confirm that the servomotor operation is correct. At the same time, carefully inspect the servomotor's condition and check the following points in particular. If a problem is found, correct it.</p> <ul style="list-style-type: none"> • Is there any unusual vibration? • Is there any unusual sound? • Is the temperature rising unusually high?
7			<p>Press the MODE/SET Key to turn the servomotor power OFF.</p> <p>Note: The servomotor power can be turned OFF by pressing the DATA/SHIFT Key for approximately one second.</p>
8			<p>Press the DATA/SHIFT Key for approximately one second. "Fn002" is displayed again.</p>
9			<p>Press the MODE/SET Key to return to the initial display (step 1).</p>

5.4 JOG Operation Using a Digital Operator

This section describes the procedure for executing a JOG operation using a digital operator.



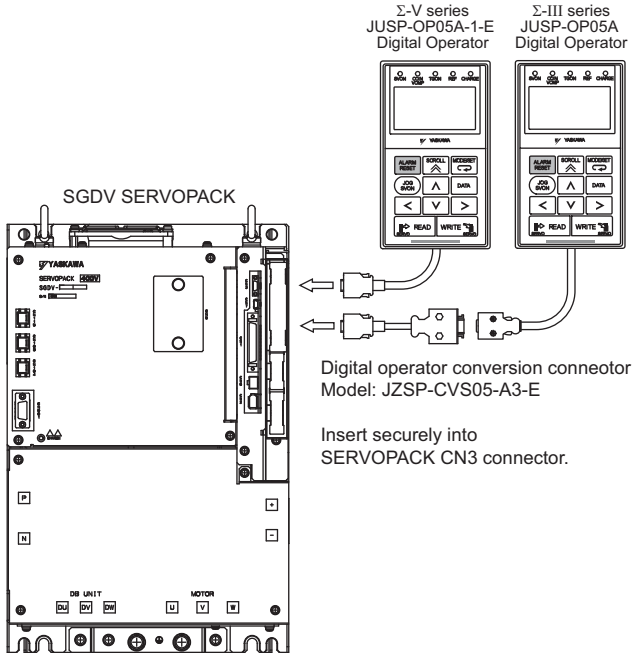



















Connect the digital operator to the SERVOPACK CN3 connector.







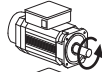

The digital operator can be connected or removed while the SERVOPACK and the converter power is ON.

Step	Display after operation	Keys	Operation
1	<pre> BB -PRM/MON- Un000= 00000 Un002= 00000 Un008= 0000000000 Un00D= 0000000000 </pre>	-	Turn ON the power to the SERVO-PACK and the converter. A message saying that the file list is being loaded will appear and then the parameter/monitor mode will appear.
2	<pre> BB -FUNCTION- Fn000:Alm History Fn002:JOG Fn003:Z-Search Fn004:Program JOG </pre>		Press the Key to view the main menu of the Utility Function mode. Press the Key or Key to select Fn002.

(cont'd)

Step	Display after operation	Keys	Operation
3	<pre> BB - JOG - Pn304=00500 Un000= 00000 Un002= 00000 Un00D= 000000000 </pre>		Press the  Key. The display changes to the execution display of Fn002.
4	<pre> BB - JOG - Pn304=0050<u>0</u> Un000= 00000 Un002= 00000 Un00D= 000000000 </pre>		Press the  Key. The cursor moves to the setting side (the right side) of Pn304 (JOG speed).
5	<pre> BB - JOG - Pn304=01<u>0</u>00 Un000= 00000 Un002= 00000 Un00D= 000000000 </pre>	   	Press the  or  Key and the  or  Key to set the JOG speed (Pn304) to 1000 min ⁻¹ .
6	<pre> BB - JOG - Pn304=01000 Un000= 00000 Un002= 00000 Un00D= 000000000 </pre>		Press the  Key. The setting value is entered, and the cursor moves to the parameter number side (the left side).
7	<pre> RUN - JOG - Pn304=01000 Un000= 00000 Un002= 00000 Un00D= 000000000 </pre>		Press the  Key. The status display changes from "BB" to "RUN", and the servomotor power turns ON.
8	<pre> RUN - JOG - Pn304=01000 Un000= 00000 Un002= 00000 Un00D= 000000000 </pre>	 	<p>The servomotor will rotate at the present speed set in Pn304 while the  Key (for forward rotation) or  Key (for reverse rotation) is pressed (The factory setting is 500 min⁻¹).</p> <div style="display: flex; justify-content: space-around; align-items: center;"> <div style="text-align: center;">  Forward </div> <div style="text-align: center;">  Reverse </div> </div> <p>Confirm that the servomotor operation is correct. At the same time, carefully inspect the servomotor's condition and check the following points in particular. If a problem is found, correct it.</p> <ul style="list-style-type: none"> • Is there any unusual vibration? • Is there any unusual sound? • Is the temperature rising unusually high?

(cont'd)

Step	Display after operation	Keys	Operation
9	<pre> BB - JOG - Pn304= 01000 Un000= 00000 Un002= 00000 Un00D= 0000000000 </pre>		<p>After having confirmed the correct motion of servomotor, press the  Key.</p> <p>The status display changes from "RUN" to "BB", and the servomotor power turns OFF.</p>
10	<pre> BB - FUNCTION - Fn000:Alm History Fn002: JOG Fn003: Z-Search Fn004: Program JOG </pre>		<p>Press the  Key to return to the main menu of the Utility Function mode.</p>
11	<pre> BB - PRM/MON - Un000= 00000 Un002= 00000 Un008= 0000000000 Un00D= 0000000000 </pre>		<p>Press the  Key twice to return to the initial display (step 1).</p>

■ Alarm Display

An alarm is automatically displayed if a problem occurs for some reason. Check the alarm using the user's manual for the corresponding SERVOPACK and converter or command option module (refer to **■ Manuals Related to the Σ -V Series** on page iv) and apply the appropriate measures.

```

A. 710          - ALARM -
A. 710 00001207196
1: 720 00000032651
2: 511 00000009043
3: ---
                    
```

■ Error Display

The following messages will be displayed if a communications error occurs between the SERVOPACK and the converter and the digital operator due to a connection problem such as poor connector contact. Check the connections and turn the power ON again. If the problem still persists, the digital operator or SERVOPACK and converter must be replaced.

```

          CPF00
          COM-ERR(OP&SV)
                    
```





```

          CPF01
          COM-ERR(OP&SV)
                    
```



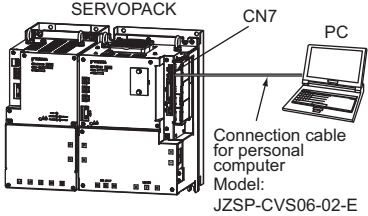

5.5 JOG Operation Using SigmaWin+

This section describes the procedure for executing a JOG operation using SigmaWin+.

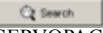
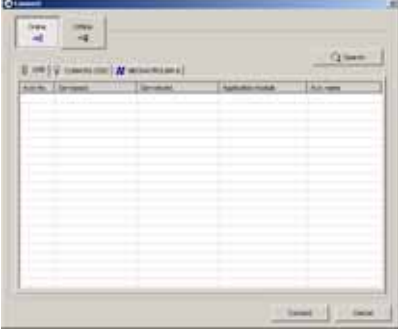

In the following example, procedures for trial operation are explained using the JOG operation window of Test Run on the main menu of SigmaWin+.

Step	Operation	Display
1	<ul style="list-style-type: none"> Connect a computer. Use a connection cable to connect a SERVOPACK and a converter to a computer which has SigmaWin+ installed. 	-
2	<ul style="list-style-type: none"> Start SigmaWin+ and open the main window. <ol style="list-style-type: none"> Turn ON the SERVOPACK and the converter. Turn ON the computer. Double click the YE_Applications folder on the desktop. Double click the SigmaWin+ icon to display the SigmaWin+ startup screen. 	 <p>YE_Applications</p>  <p>SigmaWin+ English Edition</p>  <p>Startup Screen</p>

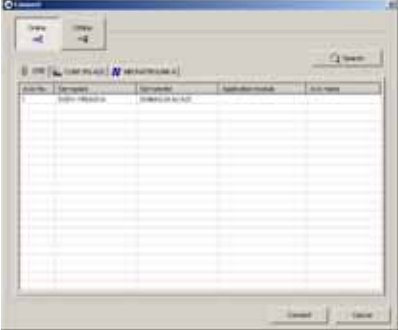
(cont'd)

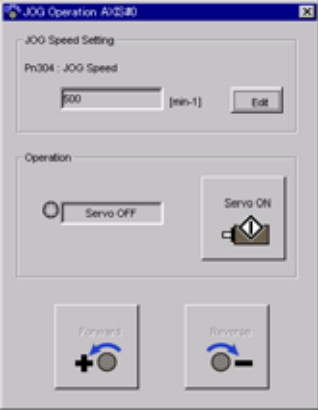

Step	Operation	Display
<p>2 (cont'd)</p>	<p>(5) Once SigmaWin+ is started, the connection window is displayed.</p> <p>Note:  is used for operation with no SERVOPACK connected.</p> <p>Click  to search for the connected SERVOPACK.</p>	 <p style="text-align: center;">Connection Window</p>
	<p>(6) Search Condition Setting window is open.</p> <p>Select Σ-V ( Σ-V), and click  .</p> <p>A dialog box will open first to tell you a search has started, and then the search result will be shown in the connection window.</p> <p>Note: If the message, “Servopack not found” is displayed, refer to 2.2 <i>Selecting a SERVOPACK</i> of SigmaWin+ English Edition Online Manual (YE_Applications -> Manual).</p>	 <p style="text-align: center;">Search Condition Setting Window</p>
	<p>(7) Select the SERVOPACK to be connected.</p> <p>Click  . (Place the cursor over the SERVOPACK to be connected, and then click on it.)</p> <p>The main window of SigmaWin+ will then open.</p>	

(cont'd)





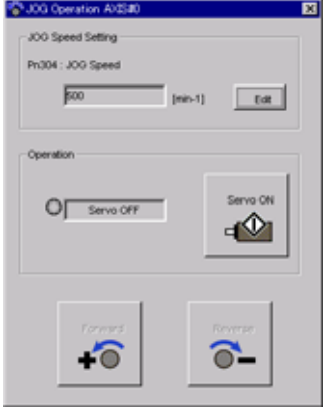

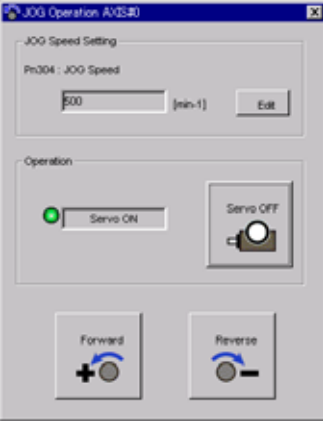
Step	Operation	Display
3	<ul style="list-style-type: none"> • Trial operation. (1) Select <i>Test Run (R)</i> first, and then select <i>Jog (J)</i> from the menu on the main window. (2) Warnings for the JOG operation window will be displayed. Read them and click . (3) The JOG operation window is open. 	<p style="text-align: center;">Test Run (R) → Jog (J)</p>  <p style="text-align: center;">Main Window</p>  <p style="text-align: center;">Warnings for the JOG Operation Window</p>  <p style="text-align: center;">JOG Operation Window</p>

Trial Operation (Checking Servomotor Operation)

(cont'd)

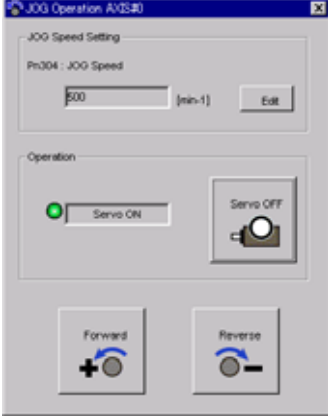
Step	Operation	Display
4	<ul style="list-style-type: none"> Set the JOG speed The motor speed is set to 500 [min⁻¹]. Click  if you need to change it. 	
5	<ul style="list-style-type: none"> Servo ON Click  . The display changes from Servo OFF to Servo ON and is lit in green.	

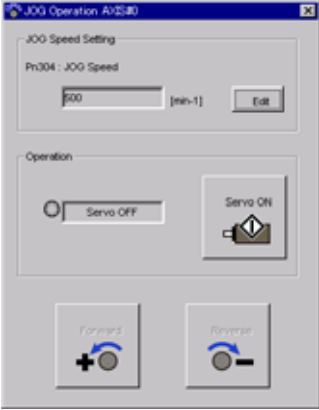
(cont'd)

Step	Operation	Display
6	<p>• Start JOG operation.</p> <p>When you click  the servomotor will rotate in the forward direction. When you click  it will rotate in reverse.</p> <p>Confirm that the servomotor operation is correct. At the same time, carefully inspect the servomotor's condition and check the following points in particular. If a problem is found, correct it.</p> <ul style="list-style-type: none"> • Is there any unusual vibration? • Is there any unusual sound? • Is the temperature rising unusually high? 	
7	<p>• Servo OFF</p> <p>Click  .</p> <p>(Screen display will return to the display shown at step 4.)</p>	
8	<p>• Terminate JOG operation.</p> <p>Click  to end JOG operation.</p>	<p>You will return to the main window.</p>

Refer to the online manual for SigmaWin+ for details. Follow the steps below to view the online manual.

<How to view the online manual>

1. Turn ON the computer.
2. Open the YE_Applications folder.
3. Open the Manual folder.
4. Open SigmaWin+ English Edition Online Manual.

Revision History

The revision dates and numbers of the revised manuals are given at the bottom of the back cover.

MANUAL NO. SIEP S800000 89B

Published in Japan January 2013 12-8 \diamond -0

Date of publication

WEB revision number

Revision number

Date of original publication

Date of Publication	Rev. No.	Section	Revised Contents
September 2013	\diamond 2	All chapters	Revision: Slightly revised
		Preface	Revision: Harmonized standards
		2.4	Addition: Descriptions related to the following SERVOPACKs: <ul style="list-style-type: none"> • SGDV-□□□□21A • SGDV-□□□□E1A Revision: Descriptions related to the following SERVOPACKs: <ul style="list-style-type: none"> • SGDV-□□□□01A • SGDV-□□□□11A Revision: Slightly revised.
		Back cover	Revision: Address
January 2013	\diamond 1	All chapters	Addition: Descriptions related to the following SERVOPACKs and converters: <ul style="list-style-type: none"> • SGDV-□□□□H SERVOPACKs, • SGDV-□□□□21A SERVOPACKs, • SGDV-□□□□E1A SERVOPACKs, • SGDV-COA□□□A converters Revision: Slightly revised
August 2012	–	–	First edition

AC Servo Drives

Σ -V Series

USER'S MANUAL

For Use with Large-Capacity Models

Setup

Rotational Motor

IRUMA BUSINESS CENTER (SOLUTION CENTER)

480, Kamifujisawa, Iruma, Saitama 358-8555, Japan
Phone 81-4-2962-5151 Fax 81-4-2962-6138
<http://www.yaskawa.co.jp>

YASKAWA AMERICA, INC.

2121 Norman Drive South, Waukegan, IL 60085, U.S.A.
Phone 1-800-YASKAWA (927-5292) or 1-847-887-7000 Fax 1-847-887-7310
<http://www.yaskawa.com>

YASKAWA ELÉTRICO DO BRASIL LTDA.

Avenida Piraporinha 777, Diadema, São Paulo, 09950-000, Brasil
Phone 55-11-3585-1100 Fax 55-11-3585-1187
<http://www.yaskawa.com.br>

YASKAWA EUROPE GmbH

Hauptstraße 185, Eschborn 65760, Germany
Phone 49-6196-569-300 Fax 49-6196-569-398
<http://www.yaskawa.eu.com>

YASKAWA ELECTRIC KOREA CORPORATION

9F, Kyobo Securities Bldg, 26-4, Yeouido-dong, Yeongdeungpo-gu, Seoul, 150-737, Korea
Phone 82-2-784-7844 Fax 82-2-784-8495
<http://www.yaskawa.co.kr>

YASKAWA ELECTRIC (SINGAPORE) PTE. LTD.

151 Lorong Chuan, #04-02A, New Tech Park 556741, Singapore
Phone 65-6282-3003 Fax 65-6289-3003
<http://www.yaskawa.com.sg>

YASKAWA ELECTRIC (CHINA) CO., LTD.

12F, Carlton Bld., No.21 HuangHe Road, HuangPu District, Shanghai 200003, China
Phone 86-21-5385-2200 Fax 86-21-5385-3299
<http://www.yaskawa.com.cn>

YASKAWA ELECTRIC (CHINA) CO., LTD. BEIJING OFFICE

Room 1011, Tower W3 Oriental Plaza, No.1 East Chang An Ave.,
Dong Cheng District, Beijing 100738, China
Phone 86-10-8518-4086 Fax 86-10-8518-4082

YASKAWA ELECTRIC TAIWAN CORPORATION

9F, 16, Nanking E. Rd., Sec. 3, Taipei 104, Taiwan
Phone 886-2-2502-5003 Fax 886-2-2505-1280



YASKAWA ELECTRIC CORPORATION

In the event that the end user of this product is to be the military and said product is to be employed in any weapons systems or the manufacture thereof, the export will fall under the relevant regulations as stipulated in the Foreign Exchange and Foreign Trade Regulations. Therefore, be sure to follow all procedures and submit all relevant documentation according to any and all rules, regulations and laws that may apply.

Specifications are subject to change without notice for ongoing product modifications and improvements.

© 2012-2013 YASKAWA ELECTRIC CORPORATION. All rights reserved.

MANUAL NO. SIEP S800000 89C

Published in Japan September 2013 12-8 

13-6-9

Original instructions